

 **Netti**[®] *III XHD*

 **Netti**[®] *III XXHD*

GMDN 41620

User Manual



CE This product conforms to
2017/745/EU for medical products.

UM0106UK 2021-03

*inspire
joy of life*

CONTENTS

1. INTRODUCTION	4
1.1 AREAS OF USE / INDICATIONS FOR NETTI III XHD & NETTI III XXHD	5
1.2 CONTRA INDICATIONS	5
1.3 QUALITY AND DURABILITY	5
1.4 THE ENVIRONMENT AND WASTE DISPOSAL	6
1.5 INFORMATION FOR RE-USE	6
1.6 ABOUT THIS MANUAL	7
1.7 VITAL MEASURES	7
2. QUICK REFERENCE	9
3. DESCRIPTION*	10
4. FEATURES OF NETTI III XHD & NETTI III XXHD	11
5. ACCESSORIES	12
5.1 MOUNTING OF HIP BELT	15
5.2 MOUNTING OF H-BELT BAR	15
6. ASSEMBLING AND ADJUSTING	16
6.1 UNPACKING (SEE CHAPTER 5 & 6)	16
6.2 DRIVE WHEELS	16
6.3 FRONT FORK	16
6.4 FRONT CASTORS	17
6.5 SEAT HEIGHT AT THE FRONT	17
6.6 SEAT HEIGHT AT THE REAR	18
6.7 BACK REST	18
6.8 ADJUSTING THE SEAT DEPTH	19
6.9 ADJUSTING SEAT DEPTH AT THE FRONT	20
6.10 ANTI-TIP	21
6.11 ADJUSTING ARM SUPPORTS	21
6.12 CUSHIONS	22
6.13 ADJUSTING THE VELCRO BACK	22
6.14 LEG SUPPORTS	23
6.15 HEAD SUPPORT	26
6.16 PUSH HANDLES	28
6.17 ADJUSTING THE BRAKES	28

7. SEAT ANGLE / TILT AND BACK ANGLE / RECLINE	30
7.1 SEAT ANGLE	30
7.2 BACKREST ANGLE	30
7.3 KEY WORDS REGARDING TILT AND RECLINE OF STATIC COMFORT WHEELCHAIRS, AND COMMON FEATURES OF DYNAMIC WHEELCHAIRS	30
7.4 DECREASE THE POSSIBILITY OF SLIDING, SHEAR AND PRESSURE SORES	31
7.5 OPERATING TILT HANDLE: TILTING THE SEATING UNIT	31
7.6 OPERATING RECLINE HANDLE: RECLINING THE CHAIR BACK	32
8. TRANSPORT	33
8.1 FOLDING FOR TRANSPORT	33
8.2 TRANSPORT IN AIR PLANE	33
8.3 TRAVELLING ON PUBLIC TRANSPORT	33
9. MANOEUVRING	34
9.1 GENERAL TECHNIQUES	34
9.2 DRIVING TECHNIQUES – STEP UP –	35
9.3 DRIVING TECHNIQUES – STEP DOWN –	35
9.4 DRIVING TECHNIQUES – SLOPE –	36
9.5 DRIVING TECHNIQUES – UP STAIRS –	36
9.6 DRIVING TECHNIQUES – DOWN STAIRS –	37
9.7 TRANSFER	37
9.8 POINT OF BALANCE	38
9.9 LIFTING THE WHEELCHAIR	39
10. MAINTENANCE	40
10.1 MAINTENANCE INSTRUCTIONS	40
10.2 CLEANING AND WASHING	40
10.3 LONG TERM STORING	41
11. TROUBLESHOOTING	42
12. TESTS & WARRANTY	43
12.1 TESTS	43
12.2 WARRANTY	43
12.3 CLAIM	43
12.4 NETTI CUSTOMIZED / INDIVIDUAL ADAPTATIONS	44
12.5 COMBINATIONS WITH OTHER PRODUCTS	44
12.6 SERVICE AND REPAIR	44
13. MEASUREMENTS & WEIGHTS	45

1. INTRODUCTION



Netti III XHD & XXHD are comfort wheelchairs meant for both indoor and outdoor use. It is tested according to EN 12183:2014. The tests were performed by TÜV SÜD Product Service GmbH in Germany.



In Alu Rehab we presuppose that wheelchairs are chosen based on a thorough assessment focusing on the needs of the user and demands from the environment.

It is therefore important to know about the possibilities and restrictions of the wheelchair. Netti III XHD & XXHD are wheelchairs designed for users with the need for comfort and relief. The combination between the seating system and the ergonomic solutions in the frame construction, offers many possibilities for adaptation and adjustments and possibilities to vary the sitting position from activity to rest using tilt and recline functions.

Netti III reinforced is available in 2 versions:

Netti III XHD seat widths: 500 – 600 mm
Netti III XXHD seat widths: 650 – 750 mm

Max user weight: 200 kg.

-  When mounting accessories such as power kit etc, the weight of the accessories must be subtracted from the max user weight.
-  Netti III XHD & XXHD are not approved for being used as a seat in a car.
-  Specifications varies between countries.

1.1 AREAS OF USE / INDICATIONS FOR NETTI III XHD & NETTI III XXHD

Netti III XHD & XXHD are multifunctional wheelchairs for wheeled transport for partially or fully immobile youth and adults with physical and / or mental disabilities. It provides a means by which a disabled person who requires the possibility to vary the sitting position from activity to rest will profit from using tilt and recline functions. It is designed for users with the need for comfort and relief. The combination between the seating system and the ergonomic solution in the frame construction offers many possibilities for adaptation and adjustments.

The disabilities may have multiple causes. Netti III XHD & XXHD have adjustable seat and back angle, thus facilitating for the user change of position, mobilization or posture correction (stabilization), wherever the following functional impediments with their multiple possible causes are present:

- limited or lacking mobility
- limited or lacking muscle power
- limited movement range
- lacking or limited trunk and body stability
- high user weight, rough use
- hemiplegia
- rheumatic-type disorders
- craniocerebral injuries, involuntary movements
- amputations
- other neurological or geriatric disorders.



If our standard solutions does not cover you needs, please contact our customer service for Netti customized solutions.

1.2 CONTRA INDICATIONS

With strongly muscular spasticity we recommend the Netti Dynamic System which offers a frame construction that follows the movement pattern of the user.

Ignoring this advice could in unfavourable circumstances lead to the deformation or fracture of metal parts in the area of the back tube, the leg rests or the arm rests.

1.3 QUALITY AND DURABILITY

The Netti III wheelchair is tested at TÜV SÜD Product Service GmbH in Germany, following the European Standard DIN EN 12183:2014.



As manufacturer, Alu Rehab A.S evaluates the test to be equal to 5–6 years of normal use of the chair. The disability of the user, the toughness of use as well as the level of maintenance does foremost decide the durability of the wheelchair. Thus, the durability will vary depending on these three factors.

1.4 THE ENVIRONMENT AND WASTE DISPOSAL



Alu Rehab and its suppliers wish to protect the environment.

This means:

- That we avoid using environmentally harmful substances and processes to the greatest extent possible.
- That Alu Rehab's products are ensured a long service life and a high degree of flexibility – to benefit the environment and economy.
- That all packaging can be recycled.
- That the wheelchair was designed to be separated into its component materials – to make recycling easier.



Contact your local recycling agent to get correct information how to handle in your area.



TEMPERATURE RANGE

Netti III XHD & XXHD wheelchairs are designed for temperature range of -10°C to +40°C.

1.5 INFORMATION FOR RE-USE

All products from Alu Rehab are designed to give years of maintenance-free service. All products can be adapted for re-use by an authorised dealer. In order to guarantee performance and safety, Alu Rehab recommends the following tests prior to any re-use.

Please examine the following components for function, integrity etc. and replace parts if necessary:

- Wheels (tyre tread)
- Wheelchair frame
- Front castors and quick release
- Hubs
- Brake function
- Directional stability of wheels
- Bearings: test for wear and lubrication.
- Cushions
- Leg supports
- Arm supports
- Recline/tilt function
- Push bar / handles
- Anti tip

For hygienic reasons: please replace the head support for a new user.

Please also note the contents of Section 10.2 Cleaning and care.

ANTI-TIP

Correctly fitted, the anti-tip will secure the chair from tipping backwards.

We strongly recommend the use of the anti-tips.

1.6 ABOUT THIS MANUAL

In order to avoid damages while using the Netti III XHD or XXHD wheelchair, please read this manual carefully before starting to use the chair.



Symbol of forbidden actions.
No warranty can be claimed whenever these actions are implemented.



Symbol of warning.
Whenever this symbol is used, caution has to be taken.



Symbol for important information.



Symbol for useful tips.



Symbol for tools.



Symbol for:
Max safe slope for hand brake.



Symbol for: Max user weight.

Please note that this manual is updated according to the year and date stated on each page.

User Manual on web

For enhanced readability (advantageous for users with visibility challenges) please find our user manual on our web page: www.My-Netti.com – manuals – user manual Netti III XHD & XXHD.

Latest user manual updates, product safety notes, addresses and other product information like recalls etc. will be published on our web page.

1.7 VITAL MEASURES

Netti III XHD and XXHD are comfort wheelchair designed for both outdoor and indoor use.



Specifications varies between countries.

TOTAL WEIGHT: 35 KG
(500 mm width chair)

SEAT WIDTH:
Netti XHD: 500, 550, 600,
Netti XXHD: 650, 700, 750 mm



SEAT DEPTH:
(From back rest cushion
to front of seat plate)
400, 425, 450, 475, 500 mm



SEAT HEIGHT:
(From floor to top seat plate
using 24" main wheels in
upper hole position).
440 mm*



* By changing position of main wheels, it is possible to achieve seat height of 475 mm. Other seating heights can be reached by changing wheel dimensions.

BACKREST HEIGHT:
500 mm*



* Using back rest extender gives 600 mm including back cushion.

** For Netti III XHD & XXHD with seat width 500 mm the total width is 240 mm more. The overall width exceeds recommended 700 mm.

*** Least stable and most stable refers to the positioning of the anti-tippers. Always use anti-tippers driving uphill.

Specification	min.	max.
Overall length with leg rest – horizontal seat. (Seat + back tilted max forward. Leg supports vertical)	1030 mm (955 mm)	1030
Overall width **	740 mm	990
Folded length	780 mm	780
Folded width (removed wheels)	710 mm	960
Folded height (removed wheels, cushions, armsupports, head + leg support)	520 mm	520
Total mass	36,0 kg	42,0 kg
Mass heaviest part: frame	17,0 kg	25,0 kg
Mass heaviest component: leg support	3,8 kg	4,0 kg
Static stability downhill		13°
Static stability uphill***	8°	15°
Static stability sideways	15°	15°
Safe slope, use anti-tipper		10°
Seat plane angle	-9°	16°
Effective seat depth	400 mm	500 mm
Effective seat width	460 mm	710 mm
Comfort Seat surface height at front	440 mm	475 mm
Backrest angle	86°	133°
Backrest height ex cushion	490 mm	590 mm
Leg support to seat distance	280 mm	560 mm
Leg to seat surface angle	105°	182°
Arm support to seat distance	185 mm	325 mm
Front location of arm support structure	300 mm	430 mm
Push rim diameter	535 mm	535 mm
Horizontal axle location	-10 mm	95 mm
Parking brake max slope	-	7°
Minimum turning radius, vertical leg supports	R 700 mm	825 mm

Model with 24" main wheels. Measured without cushions.

2. QUICK REFERENCE

The content of this page is a summary of the whole manual. It gives you a brief introduction to the use and care of the **Netti III XHD & XXHD** wheelchair.

 **The quick reference is not a replacement for the manual, only reminder / check list.**

- Unpack the wheelchair (Chapter 6.1).
- Mount the main wheels (Chapter 6.2).
- Mount the front castors (Chapter 6.4).
- Rise the back rest and mount the recline gas strut to the back rest using the locking bolt. (Chapter 6.7).
- Mount the arm supports (Chapter 6.11).
- Mount the cushions (Chapter 6.12).
- Mount the leg supports (Chapter 6.14).
- Adjust the push handles (Chapter 6.16).
- Mount the head support (Chapter 6.15).
- Set anti-tip in active position (Chapter 6.10)
- Mount accessory (See chapter 5. for more information). Mounting descriptions will follow the accessory.)

 **ADJUST THE WHEELCHAIR TO THE USER:**

Adjust seat depth and eventually the wheelchair balance, leg support height, armrest height, head support height and depth, chair back cushion height.

For more information about adapting the wheelchair to the user please see

www.My-Netti.com knowledge and tools.

 **For troubleshooting, see chapter 11. For adjustments see chapters 6.**

 **Announcements to product safety and eventually product recalls will be published on our home page www.My-Netti.com**

 **Drive carefully! Due to the size of the chair and max load, manoeuvring the wheelchair can be challenging. Driving down slopes must be done with great care.**

 **Be aware that friction against push-rims can create a warm surface.**

 **The anti-tips should always be used for the safety of the user.**

 **When the chair is tilted rearwards, the anti-tips and brakes must always be in use.**

 **Be sure to lock all handles properly.**

 **Watch out for pinching danger when folding and unfolding, tilting, reclining and all other adjustment movements.**

 **Surface temperature of metal parts in frame structure might increase when exposed to direct sunlight.**

 **Salt water can increase risk of corrosion. Further precautions related to environmental conditions not needed.**

 **Never stand on the foot plates due to risk of tipping forwards.**

 **Never lift the wheelchair by the leg supports, arm supports or head support.**

 **Product configuration may vary between different countries.**

 **For visually impaired people, manuals and catalogues can be downloaded at www.My-Netti.com**

 **If in doubt – contact your dealer!**

3. DESCRIPTION*

1. Head support
2. Back rest cushion – model Stabil
3. Arm support with pad
4. Seat cushion
5. Knee pad
6. Calf support bracket
7. Bearing house / front fork fastening
8. Quick release for front fork
9. Front fork
10. Front castors
11. Foot board lock
12. Foot board
13. Calf support
14. Angle adjustment screw
15. Height adjustment screw
16. Angle adjustment knob
18. Anti-tip
19. Brake
20. Quick release axle
21. Push ring
22. Main wheel
23. Name plate Wheelchair on lower frame cross bar.
24. Release handle for arm support
25. Release handle for push handle height adjustment
26. Push handle

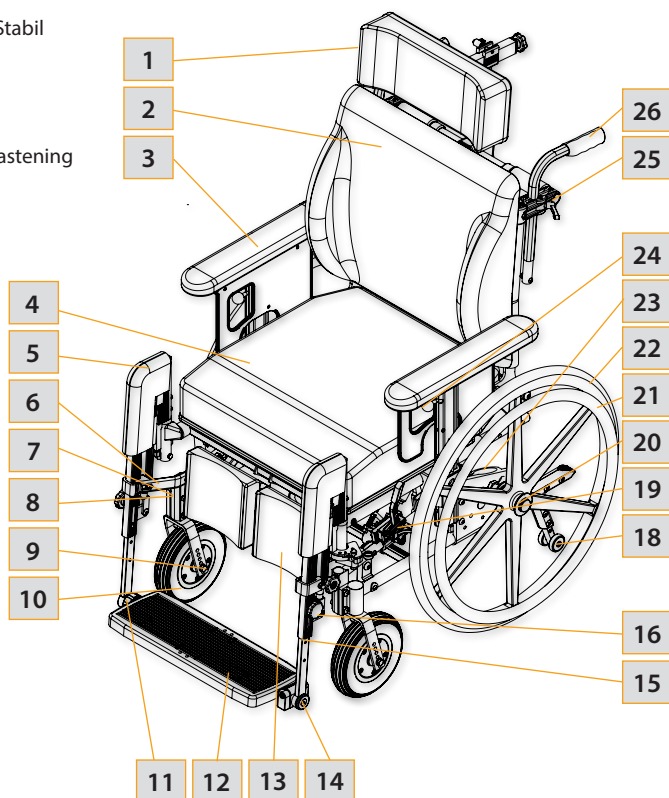

* Be aware that specifications may vary between countries.



If any of these parts are missing, please contact your dealer.



For complete information, please contact your dealer.

4. FEATURES OF NETTI III XHD & NETTI III XXHD

STANDARD

SEAT – NETTI SIT CUSHION

- Reinforced solid seat plate.
- Cushion with good pressure distributing properties
- Tilt -9° to +16°
- Double gas spring for seat tilt
- Adjustable height 400 mm to 485 mm by change of wheel size and position
- Adjustable depth up to 100 mm

WHEELS*

- 24" x 1 3/8" Puncture proof reinforced main wheels with quick release axle
- Push rim: Aluminium integrated in wheel rim
- 8" puncture proof wide front castors with reinforced 15 mm quick release axle

FRAME – Steel cross bars

PUSH HANDLES

- Height adjustable, swingable, removable.

BRAKES – User brakes

ANTI-TIP

- Height and length adjustable – swingable

BACK REST – NETTI STABIL CUSHION

- Angle: 86° – 133°
- Height: 500 mm
- Reinforced backrest hinge
- Back rest cushion with integrated lumbar support and side support, height adjustable
- Height adjustable, removable push handles.
- Double gas spring for back recline.

LEG SUPPORT – NETTI GRANDIS

- Foot board w locking bolt from sw 650 mm
- Reinforced extension pieces
- Height and angle adjustable foot plates with calf supports and knee upholstery

ARM SUPPORT

- 80 mm wide arm support pad, depth adjustable.
- Height adjustable and removable
- Reinforced arm support brackets

HEAD SUPPORT

- Height, depth and angle adjustable
- Stabilizer for head support

OPTIONS / ACCESSORIES

SEAT

- Several seat cushion models
- Universal trays (See chapter 5)
- Hip belts and 4 point belts (See chapter 5)

WHEELS

- 12 1/2" main wheels with drum brake
- Spoke protectors (See chapter 5)

BRAKES – Drum brakes

BACK REST

- Back rest extender (See chapter 5)
- Lumbar support and Wedge (See chapter 5)
- Back rest cushions – different models

LEG SUPPORT

- Netti Dynamic angle adjustable – DUAL
- Amputation support
- Knee and thigh support (See chapter 5)

ARM SUPPORT

- Different pads (See chapter 5)
- Hemi armrest and Hemi cushion (See chapter 5)

HEAD SUPPORT

- Netti Dynamic head support
- Different models (See chapter 5)

5. ACCESSORIES



The anytime updated complete accessory program is found on our web page www.My-Netti.com – order forms.



Not all accessories are available for all wheelchair configurations. Please check the homepage or ask customer service for further details.

BELTS

Several models:
Hip belts with or without upholstery and with plastic lock or car lock. (See chapter 5.1 for mounting.)



H-BELT ATTACHMENT BAR

To be mounted onto separate bars or to the push handles. Comes in two sizes with telescopic bar. (See chapter 5.2)



TRAYS

Several models:
Swingable, lockable and standard “push on” model.



UPHOLSTERY FOR TRAY

Offers a soft base for the arm resting on the tray.



WEDGE

Increases side support.



LUMBAR SUPPORT

Increases lumbar curvature.



CUSHIONS

SEAT CUSHIONS

Many to choose from.
Please contact your dealer.



BACK REST CUSHIONS

Many to choose from.
Please contact your dealer.



SPOKE PROTECTORS

For 20", 22" and 24". Black or transparent is optional.



LEG SUPPORTS

FOOT BOX NETTI GRANDIS
Upholstered.



GRANDIS LEG SUPPORT

From seat width 600 mm is it available with a single foot board and locking on one side.



NETTI DYNAMIC ANGLE

Adjustable leg support
DUAL



AMPUTATION SUPPORT



BRAKE EXTENDERS

90 mm
120 mm
250 mm



UPHOLSTERY FOR CALF SUPPORT BRACKET
Reduces pressure.



KNEE / THIGH SUPPORT
The support reduces adduction.



ABDUCTION BLOCK
The block reduces abduction.

Small: 80 mm width
Medium 110 mm width
Large: 140 mm width



HEAD SUPPORTS

Support A

Side support also available with forehead strap.

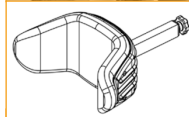

Support B

Small

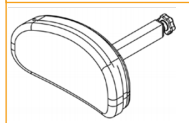

Support C

Large

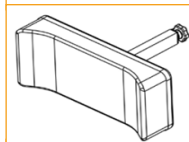

Support D

comfort pressure distributive

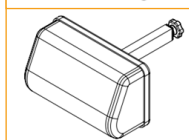

Support E

adjustable side supports

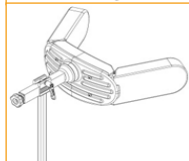

Support F

with cheek / chin support band



HYGIENE COVER

Protects the core of the head support.



HEAD CUSHION

400 x 400 mm cushion with Kospoflex filling and rubber.



HEAD CUSHION COMFORT

Cushion with Kospoflex filling to pull onto head rest.



BACK REST EXTENDER

120 mm extender.
To be used together with 600 mm back rest cushion. When using Netti III with seat width 500 mm and more as seat in car, the back rest extender and enforced head support is recommended.



ARM SUPPORT PADS

Wide: 415 x 80 mm
Long: 445 x 70 mm
Long/Wide: 525 x 80 mm
Short: 333 x 58 mm
Standard: 385 x 58 mm
Arm support pad bended



HEMI ARM SUPPORT

Offers extra support for the affected arm. Can be set in fixed positions.

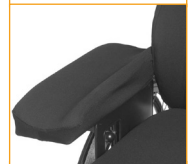

HEMI CUSHION

A more accommodating support than the hemi arm support.



COMFORT PADS

To be attached to the skirt guard. Offers a pressure distributing effect. 25 mm, 35 mm and 45 mm.



FOOT BOARD WITH LOCK

The leg supports can be swung to the side like standard leg supports.



SIDE SUPPORT STABLE

Meant for users with decreased stability of the upper trunk. For optimal function use together with Stable cushion.



PAD FOR SIDE SUPPORT STABLE



LONG BACK REST HINGE

Covers seat depth: 545, 570 and 590 mm. Must be used with extra long locking head.



EL. COMPONENTS

For tilt, back rest and leg supports, separate or complete. Please see Netti III EL with max seat width 600 mm at **My-Netti.com** for detailed information



FRAME EXTENDER

Increases distance between main wheels and front castors. Reduces tipping risk.



TOOL SET



5.1 MOUNTING OF HIP BELT

Please see www.My-Netti.com for continuously updated overview of belts and harnesses and installation instructions.

- Pull the belt through the hole in the hip belt bracket.



- Thread the belt back through the belt clamp.



- Fix the hip belt bracket to the rearmost hole in the back hinge, using the enclosed screws and nuts.



2 pcs 13 mm open-end spanner.

5.2 MOUNTING OF H-BELT BAR

- See separate mounting description MD0074 for Harness adapter kits.
- Fix the push handles in correct position and lock firmly. Then fix the bar at the right position / height. The height should be level with the shoulders of the user.



- Thread the belt through the rolls and lock the belt by pulling the belt through the belt clamp. Adjust to the requested length of belt.



6. ASSEMBLING AND ADJUSTING



6.1 UNPACKING (SEE CHAPTER 5 & 6)

1. Unpack all the parts, and check that everything is there according to the packing list.
2. Mount main wheels and front castors.
3. Mount back rest, arm supports, cushions and leg supports.
4. Mount accessories.

Weight of components (450 mm chair width):

Drive wheels:	1,90 kg each
Front castors:	0,80 kg each
Leg support Grandis:	2,60 kg each
Stabil Back:	1,35 kg
Netti Sit:	1,00 kg
Head support A:	1,00 kg
Head support C:	0,90 kg
Arm support:	1,10 kg each



Necessary tools are described under each chapter. Accessories described in chapter 5 is a presentation of options, and will be delivered with separate mounting descriptions.

When seating and wheel adjustments are done in the possible positions by standard equipment, the adjustments will not exceed safe limits.

6.2 DRIVE WHEELS

To mount the drive wheel remove the quick release bolt from the hub bushing, lead it through the centre of the main wheel and into the hub bushing while pressing the knob in centre.



-  To check that the drive wheel is properly attached to the hub, remove the finger from the central knob and pull the main wheel.
-  If the drive wheel does not lock, do not use the wheelchair but contact your dealer.
-  Sand and sea water (salt used for gritting in the winter) can damage the bearings of the main wheels. Clean the wheelchair thoroughly after exposure.

6.3 FRONT FORK

Front forks come as standard with quick release axles. The front fork is easily removed by pressing the quick release button on top of the bearing house.

-  Check angle of castor bearing house (See chapter 6.5).



6.4 FRONT CASTORS

Removing

- Press the release button on top of the front fork bearing house – through the silicon cap.



Mounting

- Lead the quick release axle into the bearing house. Pull the fork slightly to ensure that the fork is fully locked.



-  Sand and sea water (salt used for gritting in the winter) can damage the bearings of the front castors. Clean the wheelchair thoroughly after exposure.

6.5 SEAT HEIGHT AT THE FRONT

The seat height depends on:

- Size of front castors.
- Size of front fork.
- Check the angle of the castor bearing house.

In chapter 5 the overview shows that you can choose between several models of both front castors and front forks. To change the height of the front castors – unfix the wheel and replace it in the required position in the front fork.

Angle of bearing house

Correctly adjusted angle of the front fork is important to achieve good manoeuvring qualities of the wheelchair. Loosen the two screws on the inside of the frame enough to adjust the eccentric nuts. Angle the bearing house, so that it stands 90° relative to the ground.

Tighten the screws with 16 Nm

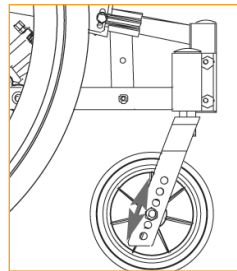

-  1 pc 5 mm Allen key.

-  The bearing house can not be adjusted in height.

-  Check and adjust the position of the anti tip if necessary.

6.6 SEAT HEIGHT AT THE REAR

The seat height at the rear depends on:

- Size of main wheel.
- Position of main wheel.

Main wheel

Loosen the hub bushing, including washer and nut, and mount it in required position in the main wheel bracket.



2 pcs 24 mm open-end spanner.



Make sure that the nut on inside of frame totally wreathes the wheel bushing.



When the seat height is changed make sure that the bearing house of the front castors are adjusted vertical to the ground (See chapter 6.5).



The risk for tipping increases when the main wheel is moved forward in the main wheel bracket.



Check the position of anti-tip.



Readjust the brakes (See chapter 6.17).

6.7 BACK REST

- Unfold and lift the back rest up and fit the gas strut into the bracket.
- Secure the back rest by pushing the locking bolt in from the side, through the bracket and gas strut head.



If the gas strut does not seem to fit, use the lower horizontal bar on the back rest to compress the gas cylinder. Hold the recline handle pushed in while you press the bar towards the gas cylinder and thereby compress it. Let the handle lose and fit the gas cylinder into the gas strut head.

6.8 ADJUSTING THE SEAT DEPTH

The seat depth can be adjusted both in the back and in the front of the seat. Adjustments are done to give the user a comfortable seating position with proper lumbar support while the knee joint is aligned with the leg support knee joint.

By adjusting the seat depth the chair balance and the driving characteristics may change. A well balanced chair is easy to drive without easily tipping backwards. Always start with adjusting the seat depth backwards, then adjust the leg support fixing bracket to make the leg support knee joint align with the user knee joint. If necessary the driving wheel position also needs to be change.

The seat depth can be adjusted 100 mm in the rear and 100 mm in front.

ADJUSTING SEAT DEPTH AT THE REAR

Adjusting seat depth at the rear:

- The back rest hinge has 5 holes with 25 mm distance between them.
- The seat depth can be adjusted from 400 – 500 mm (Measured from front of seat plate to backrest tube without backrest cushion).
- On the frame under the chair plate there is mounted an extra locking head for the gas strut.
- The short locking head covers seat depth 400 mm, 425 mm and 450 mm.
- The long locking head covers seat depth 450 mm, 475 mm and 500 mm. (There is also a long back rest hinge which covers longer seat depths. See chapter 5).



- When changing the position of the back rest hinge, also remember to change the position of the gas strut under the chair. The bracket has 3 holes. When the back rest hinge is set in the shortest position, the gas spring is placed in the front hole using the short locking head.



For each position the back rest hinge is pulled out, the gas spring is moved one hole towards the rear. When the gas spring reaches the rearmost hole with short locking head, change to long locking head and start from the front hole again.



When using the comfort seat plate it is recommended to change seat plate when changing seat depth. The seat plate comes in depth: 400 mm, 430 mm & 460 mm.



By using the Velcro adjustment straps in the chair-back you can gain a few cm on the depth.

Seat depth in the rear is adjusted as follows:

- Release the tilt gas strut by tilting the seat all the way forward.
- Pull out the locking bolt for the backrest, and place the back rest forward in the seat.
- Remove the screws holding the back rest hinge, and set the hinge to a position which gives the backrest the required position. Do both sides at the same time.
- Replace the backrest screws and fix them.
- Remember to move the gas strut as described earlier in this chapter – to reach 90° back angle when the gas strut bottoms.



When adjusting the seat depth at the rear, the screw in the backrest hinge must be tightened with 14 Nm.



6 mm Allen key.
13 mm open-end spanner.



If the user requires another back rest angle than what is standard, it is possible to change the position of the gas strut in three positions under the chair in front.



When changing seat depth, you also change the tipping point of the chair. This can be prevented by changing the position of the main wheel in the main wheel bracket (See chapter 6.6). Adjust anti-tippers accordingly (See chapter 6.10).

6.9 ADJUSTING SEAT DEPTH AT THE FRONT

It is possible to adjust the seat depth up to 100 mm at the front. By restless users the extension piece should not be pulled out more than 50 mm.

Do the following:

- Loosen the screw holding the extension piece for the leg support.
- Set the extension piece to the required position.
- Fix the screws, tighten them with 25 Nm.



6 mm Allen key.



By setting the extension piece to different positions, it is possible to compensate for a rotated pelvis or different length of thighs.

6.10 ANTI-TIP

- Adjust the anti-tip so that it does not stick outside the radius of the wheel.
- Pull the anti-tip out / rearwards from the chassis.
- Turn it down 180°.
- Lock it in position by moving forwards with the spring tension.



- i** The anti-tips are delivered adjusted according to ordered main wheel size in standard position. If other adjustments are carried out, anti-tips have to be adjusted accordingly.

Adjusting anti-tip

The anti-tips must be adjusted whenever the position or dimension of the main wheels are changed.

Correctly adjusted anti-tips should be positioned just on the inside of the radius of the main wheel.

Anti-tips are adjusted as follows:

- Unfix the locking clamp on the anti-tip bar using an Allen key.
- Pull or push the bar to required position.
- Fix the locking clamp.
- Do the same procedure on the opposite side.

- wrench** 6 mm Allen key.

- !** Check that both anti-tips have the same length. The gap between the anti-tip wheels and the floor must be 20 – 30 mm.

- !** If the anti-tip is positioned on the outside of the main wheel radius, it will interfere with curbs and stairs.

- !** The anti-tip should always be used for the safety of the user.

6.11 ADJUSTING ARM SUPPORTS

- Turn the arm support release handle to the side and hold.
- Adjust the armrest to the required height and release the handle. Lift or lower the armrest slightly until it locks.



- thumbs up** The arm pad and locking screw are set in the middle position. This can be adjusted to fit the user.

6.12 CUSHIONS

Cushions are fixed and adjusted on the wheelchair using the Velcro.



It is imperative to correctly set-up the cushion in order to ensure good seating comfort.



The cushion covers are washable and thereby reusable. Follow the instruction on the back of the cushion for correct maintenance and washing of the cushion.

6.13 ADJUSTING THE VELCRO BACK

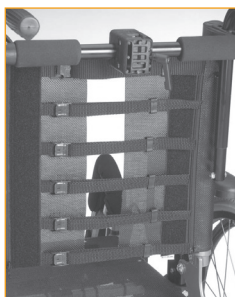

- Loosen the straps, and place the back rest cushion so that user gets room for the bottom and the integrated lumbar support in correct position.
- Tighten the straps so that they follow the curvature of the spine and gives a little extra support at the top of the sacrum.

6.14 LEG SUPPORTS

Netti III XHD & XXHD has following alternative leg supports:

- Netti Grandis angle adjustable leg support
- Netti Dynamic leg support DUAL
- Amputation leg support
(See chapter 5 for pictures).

As standard **Netti III XHD & XXHD** are delivered with Netti Grandis angle adjustable leg support. From seat width 650 mm the leg supports are delivered with a foot board and locking on the left side leg support.

A separate User Manual – UM0119 for Netti Grandis leg support is available on our home page My-Netti.com

Please see the separate User Manual UM0115 for Netti Dynamic Leg support DUAL.

Netti Grandis leg support is swingable and removable. It is height adjustable and comes with height- and depth adjustable calf supports. The foot plates are hinged and swing up sideways. When folded down they can be angled in fixed positions. As a standard the foot plates come with a lock connecting the 2 plates, increasing the strength and reducing maintenance. If locking is not wanted, the locking bolt can be removed by using an Allen key.

MOUNTING OF GRANDIS LEG SUPPORT

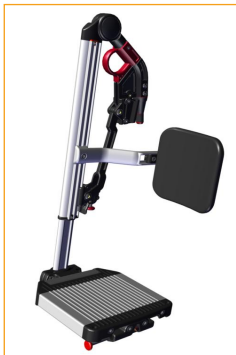

How to mount:

- Fold the foot plates up.
- Hold the leg support on the top joint, and place it in the pull-out-piece in an angle as shown in the picture below.
- Swing the leg support inwards and push slightly downwards until it goes into locked position.

Leg rest angle adjustment:

To adjust the angle of the leg support simply release the red lever and lift or lower. The leg support will stay in the position where you lock the lever.



Foot plate height adjustment:

The foot plates are step less height adjustable.

- Loosen the adjustment screw so that the adjustment bar moves freely.
- Slide the foot plate to required height, then tighten the screw.

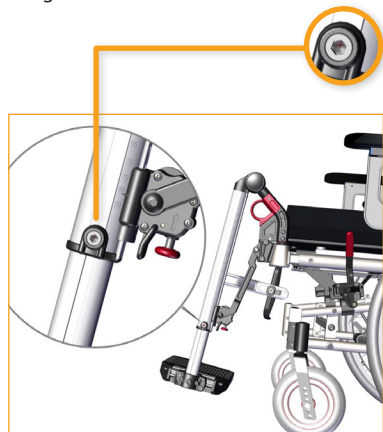

Foot plate depth adjustment:

- Loosen the 2 screws completely as shown below, using an 5 mm Allen key.
- Pull out the foot plate and loosen the next 2 screws which has become visible.
- Slide the footplate forwards or backwards to desired depth before refixing all screws.

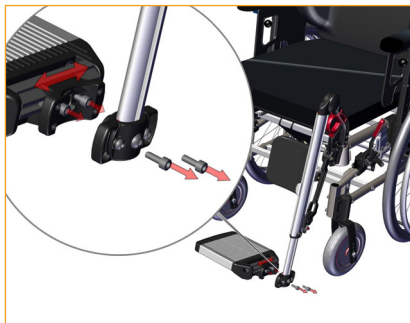

Foot plate angle adjustment:





- Loosen the 2 screws as shown below using an 5 mm Allen key.
- Adjust the foot plate to the required angle and tighten the screws.



Locking and releasing the foot plates

- The foot plates come with a lock connecting the 2 foot plates which makes the plates stronger.
- To lock the foot plates let the right foot plate fall over the bolt standing out from the left one, it clicks into lock.
- To release the foot plate push the plastic knob under the right foot plate and lift the right foot plate up.



-  While making the adjustment, there must be no load on the foot plates.
-  For outdoor use, there should be a clearance of 40–50 mm between the foot plate and the ground.
-  Never stand on the foot plates due to the risk of tipping forward.
-  When adjusting leg support angle, be aware of squeeze hazard between moving parts.

Removing the leg support:

- Release the foot plate by pushing the red plastic knob under the right foot plate and lift the right foot plate up.
- Pull the red circular grip on top of the leg support and lift the support upwards while turning it slightly outwards.



Calf support adjustment



The calf support is height and depth adjustable. The calf supports are to be adjusted in a height and depth that prevents the feet from sliding down from the foot plate.

To adjust the height, loosen the screw on the calf support bracket and slide it into required position before fixing the screw.

-  5 mm Allen key.



To adjust in depth of the calf pad, loosen the screw holding the calf support and slide it to required position before fixing the screw again.

-  5 mm Allen key.
-  Never stand on the foot plates!
-  Never lift the wheelchair by the leg supports.

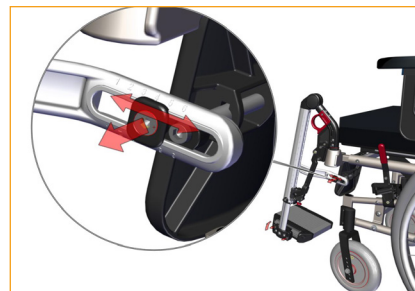

Netti III XHD and Netti XXHD with Grandis leg support with foot board from seat width 650 mm:



Amputation support



6.15 HEAD SUPPORT

- A – Lever for depth adjustment
- B – Wheel for angle adjustment
- C – Lever for height adjustment
- D – Head support bracket.

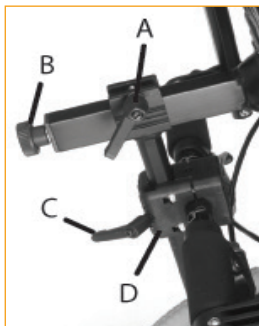

- Place the squared nut in the trace of the head support bracket as shown below.





- Place the head support in the head support bracket.
- The height and the depth of the head support is set to the required positions and tightened.
- The head support bracket is fixed by tightening the four screws two by two diagonally so the bracket is fixed with the same strength divided on the four screws.

The head support stabilizer helps the head support fixing bracket keeping its position and direction when it is mounted to a wide wheelchair.



 **Remember to release the levers when adjusting the head support.**

 **If the head support stand does not fit the bracket perfectly the bracket is probably fixed too tight or unevenly. After fitting the head support, fix it properly by tightening the little set screw in the centre on top of the head support bracket using an Allen-key.**

 **If the head support seems too short in height, it can be turned 180° by releasing the adjustment wheel at the rear of the horizontal bar (B) .**

Adjusting the head support in depth:

- Release the locking lever on top of the vertical bar (A).
- Adjust the head support and fix it in required position.

Adjusting the head support in height:

- Release the locking lever on the head support adapter (C).
- Adjust the head support and fix it in required position.

Adjusting the head support in angle:

- Release the adjustment wheel at the rear of the horizontal bar (B).
- Adjust the head support and fix it in required position.

Adjusting the head support sideways:

- The head support adapter can be moved both to the right and left, giving the possibility to accommodate special needs for head support.
- Loosen the four screws holding the adapter together.
- Move the adapter to the required position and fix the adapter by tightening the screws diagonally.

6.16 PUSH HANDLES

Adjustment of push handles:

- Release the lever on the side and lift the handle all the way up.
- Turn the handles into required position.
- Adjust height.
- Lock the handle in required position by tightening the lever.



Check that the safety screw is properly tightened.



To remove the handles, the safety screw at the bottom of the handles has to be removed.

6.17 ADJUSTING THE BRAKES

- The knee lever brakes are freely adjustable along the frame tube.
- To activate the brake, push the handle forward.



- To release the brake, pull the handle rearwards.





- To reposition the brake, loosen the two screws on the inside of the brake clamp.



- For fine adjustment, loosen the upper screw on the inside of the brakes.
- Adjust the brake position and tighten the screws.



5 mm Allen key.

-  Check that the brakes are correctly adjusted by activating the brakes and test that the wheelchair does not move.
-  The knee lever brakes are constructed as parking brakes and shall not be used as driving brakes.
-  Be aware of potential squeeze hazard between brake and tyre.

DRUM BRAKE

Netti III XHD & XXHD are as standard fitted with hand operated drum brakes.



If the brake does not brake properly:
Adjust the wire on one or both sides, adjust the foot screw 2 – 4 rounds out. Then re-check the brakes.

If the wire is too loose:
Adjust the foot screw all the way in. Tighten the wire by loosening the wire clamp before pulling the wire further through it. Tighten the wire clamp, and adjust the foot screw out again.



 1 pc 10 mm open-end spanner.

 To ensure the correct functions of the wire, these must never be taut.

Operating and applying the drum brake

The wheelchair with drum brake allow regulation of speed on hills and whilst traveling along. The brake levers are located on the push handles.

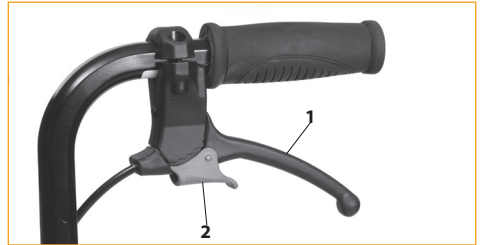

- To apply the brakes, pull the brake levers (1) evenly and smoothly towards handle and bring the wheelchair to a stop.
- For activating and locking the parking brake (2) press the lever (1) against the push handle and lock the parking brake with the finger. Be sure that both parking brakes are locked.
- The parking brake will be released when you press the lever (1) against the push handle. It is locked with a spring and this will release it.

 Do not leave the user in the wheelchair without activating the parking brake.

7. SEAT ANGLE / TILT AND BACK ANGLE / RECLINE

7.1 SEAT ANGLE

The seat angle is regulated using the **tilt** release handle mounted on the push bar.

The seat unit can be tilted from -9° to $+16^{\circ}$.



7.2 BACKREST ANGLE

The backrest angle is regulated using the **recline** release handle mounted on the push bar. The angle can be regulated from 4° forward to 40° backwards.

 **To ensure correct function of the wires, these must never be taut.**

 **The seat and back-rest angle must not be adjusted without using the anti-tips.**

The release handles has each on of the following label:





Tilt



Recline

 **Risk for tipping.**
Check the position of anti-tip.

 **When chair back extension is mounted, the tipping risk increases. If necessary it should be improved by moving the main wheels further back.**

 **Always use anti tippers when recline and tilt functions are seeing activated.**

7.3 KEY WORDS REGARDING TILT AND RECLINE OF STATIC COMFORT WHEELCHAIRS

Tilt and **recline** are the basic benefits of a comfort wheelchair. It allows for varying seating positions during the time in the wheelchair.

We have reviewed the clinical evidences regarding tilt and recline, and found there are several studies or best practice guidelines suggesting that the tilt and recline sequence is important to reduce shear and sliding:

First tilt then recline afterwards. When bringing the client upright again, the sequence should be recline first then tilt. It would seem that the most shear would be induced when going upright from a recline and tilted position.

7.4 DECREASE THE POSSIBILITY OF SLIDING, SHEAR AND PRESSURE SORES:

Only use the tilt angle to achieve variation of the seating position for the user. It is common knowledge that recline should not be adjusted after the back angle is accommodated to the user's best seating position.

The muscle tone of the neck and back should be as low as possible for the user to prevent sliding, and a change of the recline angle from the original position will interrupt and destroy the correct body position, and cause an increased muscle tone in the neck.

If the recline function is used during a transfer situation or other situations, it is very important that the recline angle is adjusted back to the correct, original position when the user is back to a normal seating position.

Wrong usage of recline causes an increased possibility of sliding, and this means an increased danger of shear (vertical and horizontal forces) and pressure sores.

MAKE SURE THAT THE USER IS SAFE WHEN THE TILT OR RECLINE FEATURES ARE GOING TO BE ADJUSTED:

The tilt and recline functions of all Netti comfort wheelchair models is a «one hand operation», including the dynamic wheelchair models. This is a great benefit for the user: The care giver is able to establish eye contact with the user when the tilt or recline function is going to be used. The care giver is also able to communicate with the user before the tilt or recline function is used. The user will feel more safe when he / she is aware that the tilt or recline function is going to be used.

7.5 OPERATING TILT HANDLE: TILTING THE SEATING UNIT

Press the left handle on the push bar and put pressure to the push bar to tilt the seating unit with one of your hands, while you have eye contact with the user and put the other hand on the arm support.

The correct relative angle between the body parts remain the same when the seating unit is tilted.

Wherever you let the handle loose, the seating unit will stay in this position. To bring the seating unit up, press the handle and the tilt cylinder will assist you lifting the seating unit up.

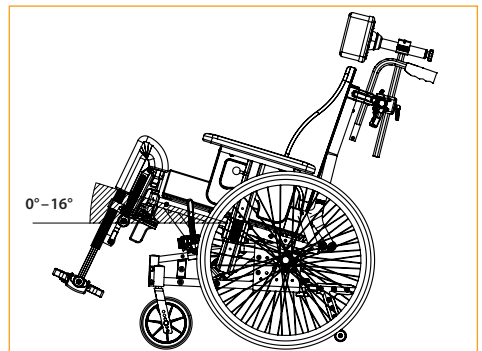

A backward tilted seat unit gives a steeper seating angle in relation to the surface, and prevent sliding of the wheelchair user.

A forward tilted seat unit brings the user in a position where activities – for instance by a table or by standing up from the wheelchair, is supported.

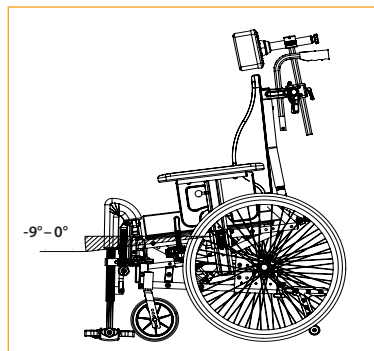

The tilt handle and the tilt sign is on the push bar – shown on the previous page.



Never leave the user alone when the seat is tilted forwards. The user can slide forward.

7.6 OPERATING RECLINE HANDLE: RECLINING THE CHAIR BACK

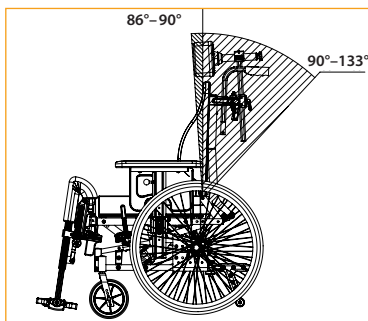

Press the right handle and put pressure to the push bar to recline the back with one of your hands, while you have eye contact with the user and put the other hand on the arm support. Wherever you let the handle loose, the chair back will stay fixed and locked.



8. TRANSPORT

Netti III XHD & XXHD are NOT approved for to be used as a seat in a vehicle.



-  **Netti III XHD & XXHD with seat width 500 mm and more, exceed the max width of 700 mm specified in PRM-TSI and have influence on the possibility for train transport.**
-  **Netti III XHD with seat width 500 mm and more, exceed the max width of 700 mm and may cause problems passing through doors and other openings.**
-  **Please be aware that wider wheelchairs have bigger turning radius and reduced manoeuvrability in vehicles. Smaller wheelchairs generally provide greater ease of vehicle access and manoeuvrability to a forward facing position.**

8.1 FOLDING FOR TRANSPORT

When the wheelchair is unoccupied, fold it as described below. Put the wheelchair in the trunk or the back seat. When placed in the back seat, secure the frame using safety belts.

- Remove head support (chapt. 6.15)
- Turn anti tips up (chapt. 6.10)
- Swing push handles in (chapt. 6.16)
- Remove arm supports (chapt. 6.11)
- Remove foot supports (chapt. 6.14)
- Remove backrest cushion (chapt. 6.12)
- Release backrest and fold it (chapt. 6.7)
- Remove main wheel (chapt. 6.2)
- Remove front castor (chapt. 6.4).

8.2 TRANSPORT IN AIR PLANE

Netti III XHD & XXHD wheelchair may be transported in air plane without any restrictions. Netti III XHD & XXHD wheelchairs are equipped with 4 gas springs. These are however not classified as dangerous goods. Contrary to general dangerous goods instruction UN3164, the IATA-DGR (special regulation A114) rules that the goods that contain gas and are determined to function as shock absorbers (including energy-absorbing devices or pneumatic springs) are NOT subject to the transport instructions i. e. they are indemnified from the following requirements:

- a) Each article has a gas volume which does not exceed 1,6 l and a charge pressure not exceeding 250 bar, where the product of the capacity expressed in litres and charge pressure expressed in bars does not exceed 80.
- b) Each article has a minimum burst pressure of 4 times the charge pressure at +20° Celsius for products not exceeding 0,5 l gas space capacity.
- c) Each article is made of material that will not fragment.
- d) Each article was manufactured in accordance to quality standard which is approved by the responsible national authority
- e) It is proven and shown that the article relieves its pressure by means of a fire degradable seal or other pressure relief device such that the article will not fragment and the article does not rocket.

8.3 TRAVELLING ON PUBLIC TRANSPORT







The wheelchair should be put in a special area for wheelchairs. The wheelchair should face opposite the direction of travel. The back of the wheelchair must be located against a fixed object such as a row of seats or a partition.

9. MANOEUVRING

9.1 GENERAL TECHNIQUES

The weight and balance of the chair influences the manoeuvring ability of the wheelchair.

The weight, size and sitting position of the user are also influencing factors. The position of the wheels will influence the driving performance. The more weight placed over the main wheels, the easier it is to manoeuvre. If heavy weight is placed over the front castors, the chair will be heavy to manoeuvre.

-  **Netti III XHD & XXHD can be challenging to manoeuvre due to size and load. Be very careful when driving on any not horizontal surface. You may lose control.**
-  **Step approach:**
Always approach the step in slow motion preventing the front castors to hit the step with force. The user could fall out of the chair by the impact. The front castors could brake.
-  **Driving forward down steps / sidewalks** Be cautious that you do not drive down steps higher than 30 mm. The leg supports may hit the ground first. Thereby you might lose control and the leg supports may brake.
-  **Companion:**
If the user is left alone in the wheelchair, always lock the brakes and secure that the anti-tips are turned down.
-  **Parking:**
Increase the underneath support of the wheelchair by moving the chair about 100 mm backwards making the front castors turn forward.
-  **Driving on soft, rough or slippery ground** can make safe manoeuvring more difficult as the wheels may lose traction and it is difficult to control the wheelchair.
-  **EMERGENCY ESCAPE ROUTES:**
Netti III XHD with seat width 500 mm and more, has an overall width exceeding 700 mm and may have difficulties passing emergency escape routes.

9.2 DRIVING TECHNIQUES – STEP UP –



Companions, drive up a step forwards:

- Check that the anti-tip is turned up.
- Angle the wheelchair backwards.
- Lift the push handles while pushing the chair onto the step.

 **Turn the anti-tip down.**

Users, drive up a step backwards:

This technique is only useful if the step is very low. It also depends on the clearance between the foot plates and the ground.

- Check that the anti-tip is turned up.
- Drive the chair backwards towards the step.
- Make a firm grip on the push rims and move the body forward while pulling.
- Pull the wheelchair up the step and backwards long enough to get the front castors on the step.

 **Turn the anti-tip down.**

Companions, drive up a step backwards:

- Check that the anti-tip is turned up.
- Pull the chair backwards next to the step.
- Angle the wheelchair backwards, moving the front castors slightly up in the air.
- Pull the wheelchair up the step and go backwards long enough to put down the front castors on the step.

 **Turn the anti-tip down.**

9.3 DRIVING TECHNIQUES – STEP DOWN –

Companions, drive down a step forwards:

- Check that the anti-tip is turned up.
- Angle the wheelchair backwards, moving the front castors slightly up in the air.
- Drive carefully down the step and angle the wheelchair forward putting the front castors back on the ground.

 **Turn the anti-tip down.**





Companions, drive down a step backwards:

- Check that the anti-tip is turned up.
- Move the wheelchair backwards to the step.
- Drive carefully down the step and move the wheelchair backwards on the main wheels until the front castors have come away from the step.
- Put the front castors down on the ground.

 **Turn the anti-tip down.**

9.4 DRIVING TECHNIQUES – SLOPE –

Important advise for driving down and up hill avoiding the risk of tipping. Be very careful and take into considerations the required strength necessary to brake and control a big wheelchair on a slope.

-  **Avoid turning the wheelchair in the middle of a slope.**
-  **Always drive as straight as possible.**
-  **It is better to ask for assistance than taking risks.**
-  **Always be extra careful when driving up and down hills and slope due to the size and the weight of the chair.
It may become too heavy to stop the chair.**

Users, driving uphill:

Move the upper part of the body forwards in order to maintain the balance of the chair.

Users, driving downhill:

Move the upper part of the body backwards to maintain balance of the chair.

Control the speed of the chair by clutching the push rims.



Attendant:

Do not use the parking brakes on the tires.
Use the drum brakes.

Be careful not to make a sudden stop, the user may fall out of the chair.



9.5 DRIVING TECHNIQUES – UP STAIRS –

-  **Always ask for assistance.**
-  **Never use escalators, even if assisted by a companion.**

With assistance, backwards:

- Check that the anti-tip is turned up, and that the push handles are fixed properly.
- Pull the wheelchair backwards to the first step of the stairs.
- Angle the wheelchair backwards on the main wheels.
- Pull the wheelchair slowly up the stair, one step at the time keeping the balance on the main wheel.
- Reaching the top of the stair, pull the wheelchair backwards far enough to put the front castors safely down on the floor.



**If two companions are present, one person can assist lifting in the front of the frame.
Lifting points on the frame are marked with this sign:**



The companions should use the strength in their legs carrying the chair, avoiding unnecessary stress on the back.



Do not lift the wheelchair holding onto the leg, arm or head supports.



Turn the anti-tip down.

9.6 DRIVING TECHNIQUES – DOWN STAIRS –

-  **Never use escalators, even if assisted by a companion.**

With assistance, forwards:

- Check that the anti-tip is turned up and that the push handles are fixed properly.
- Drive the wheelchair forward to the first step of the stair.
- Angle the wheelchair backwards on the main wheels.
- Have a firm grip on the push handles, and keep the balance on the main wheel taking one step at the time.
- Reaching the bottom of the stair, put the front castors safely down on the floor.

-  **If two companions are present, one person can assist lifting in the front of the frame. Lifting points on the frame are marked with this sign:**



-  **Do not lift the wheelchair holding onto the leg, arm or head supports.**

-  **Turn the anti-tip down.**

9.7 TRANSFER

Techniques for transferring to / from the wheelchair should be practiced well with the persons involved. Here, we give some important advices for preparation of the chair:



With or without companion – sideways.

Before transfer:

- The wheelchair should be placed as close as possible to the destination of the transfer.
- Pull the wheelchair backwards 50 – 100 mm in order to make the front castors turn forward.
- Lock the brakes.
- Remove foot support and arm support on the side of the transfer.

With or without companion – forwards.

Before transfer:

- The wheelchair should be placed as close as possible to the destination of the transfer.
- Pull the wheelchair backwards 50 – 100 mm in order to make the front castors turn forward.
- Lock the brakes.
- Tilt chair forward.

USING A LIFT:

Before transfer to chair:

- Tilt the chair seating unit a little.
- Remove the head support.
- Remove the leg supports.
- Recline / open the back rest angle slightly to give space for the belt behind the back of the user.
- Replace the components when the transfer is finished.



-  **Never stand on the foot plates due to the risk of tipping the chair forwards.**

9.8 POINT OF BALANCE

Adjust the point of balance by changing the position of the main wheel in the main wheel bracket.

- Move the main wheel hub and the main wheel (chapt. 6.6).
- Adjust the brakes. (chapt. 6.17).



2 pcs 24 mm open-end spanner.



5 mm Allen key.

When the main wheels are moved forward, it will be easier to manoeuvre the wheelchair, but the risk of tipping backwards increases.



The point of balance can also be changed by adjusting the seat depth, the seat angle and / or angle of the backrest.



Always use the anti-tip.



Check that the main wheel and quick release are locked properly (chapt. 6.2).

9.9 LIFTING THE WHEELCHAIR

- The unfolded wheelchair should be lifted from 2 persons holding on to the frame and push bar only. It is marked with the below symbol where it should be lifted.



Never lift the wheelchair in the leg, arm or head supports. They may detach and the wheelchair may fall and get damaged.



Never lift the wheelchair with a user in it.

10. MAINTENANCE

10.1 MAINTENANCE INSTRUCTIONS

 You as a user of the wheelchair (and your attendants and family) are responsible for the everyday maintenance of the chair. Clean it regularly and do the maintenance to assure safe and long time reliable functions and hygienic appearance.

Frequency	Weekly	Monthly
Check defects / damages e. g. breakage / missing parts	X	
Washing of wheelchair		X
Washing of cushions		X
Check anti-tip function		X
Check brake adjustment		X
Check tyre wear		X
Oiling of bearings with bicycle oil		X
Grease vertical leg support profiles with white vaseline	X	

10.2 CLEANING AND WASHING

1. Remove cushions before washing the wheelchair.
2. Clean the frame using water and a rag.
3. We recommend using soft soap.
4. Rinse the wheelchair well using clean water to remove all the soap.
5. Use methylate spirit to remove any dirt left.
6. Clean cushions and covers according to instructions printed on cushions.

NETTI CUSHION CLEANING PROCEDURES

CORE	
Washing	Hand wash 40° C
Disinfection	Virkon S
	Auto clave 105° C
Drying	Squeeze
	Air dry standing edgewise
OUTER COVER	
Washing	Machine wash 60° C
Drying	Tumble dry max. 85° C

DISINFECTION OF THE WHEELCHAIR

Remove cushions.

See separate washing instruction above:
Wipe disinfection: use a soft rag wetted with Hydrogen peroxide or technical alcohol (isopropanol) and wipe the whole chair clean. Hydrogen peroxide recommended: NU-CIDEX "Johnsen and Johnsen".



Check / re-adjust screws and nuts at regular intervals.



Sand and sea water (salt used for gritting in the winter) can damage the bearings of the front castors and main wheels. Clean the wheelchair thoroughly after use.

* As a rule of thumb, use oil on movable parts and all bearings. Alu Rehab recommends use of ordinary bicycle oil.

10.3 LONG TERM STORING

If the wheelchair is stored for longer time – (longer than 4 months) no particular actions are needed. We recommend that the chair is cleaned before storing. Before it being used again, complete the above maintenance instructions.

SPARE PARTS

The Netti chairs are built of modules. Alu Rehab carries stock of all parts and is ready to supply these on short notice. Necessary instructions for mounting will follow the parts.

Parts to be handled by user are defined in spare part catalogues that can be downloaded at www.My-Netti.com.

These parts can, if needed, also be removed and sent to manufacturer / distributor upon request.



Parts related to wheelchair frame construction must be handled by manufacturer or authorized service facility.



If defects or damages occur, please contact your dealer.



Original paint for repair of scratched, can be ordered from Alu Rehab.

11. TROUBLESHOOTING

Symptom	Reason / Action	Reference in manual
The wheelchair is going askew	<ul style="list-style-type: none"> The angle of the bearing house might not be 90°. Check that the front castors are fitted in the same height. The main wheel hubs might be incorrectly mounted. One of the brakes might be too tight. The user are sitting very askew in the chair. The user might be stronger on one side than the other. 	<p>6.4</p> <p>6.3</p> <p>6.6</p> <p>6.17</p>
The wheelchair is heavy to manoeuvre	<ul style="list-style-type: none"> The main wheel hubs might be incorrectly mounted. Clean the front castors and forks for dirt. Too much weight over the front castors (Adjust the point of balance by moving the main wheels back). 	6.6
The wheelchair is hard to turn	<ul style="list-style-type: none"> Control that the front castors are not fixed too tight. Adjust the angle of the bearing house. Too much weight over the front castors adjust the point of balance. 	<p>6.4</p> <p>6.5</p>
The front castors are wobbling	<ul style="list-style-type: none"> The front castors are not fixed properly. Check that the front forks are fitted in the same height. The angle of the bearing house might not be 90°. Too much weight over the front castors adjust the point of balance. 	<p>6.4</p> <p>6.4</p> <p>6.3</p> <p>6.5</p>
The main wheels are difficult to take off and put on	<ul style="list-style-type: none"> Clean and grease the quick release. Adjust the length of the hub bushing. 	6.6
The brakes are not functioning well	<ul style="list-style-type: none"> Check the wheels and the distance to the brakes. Adjust the brake. 	6.17
The wheelchair feels "shaky"	<ul style="list-style-type: none"> Check screws and adjustment points in general. 	



Please contact your dealer for information about authorized service facilities that can give support if solution is not reached in this form.



When in need of spare parts, please contact your dealer.



When making changes affecting frame construction, contact dealer / manufacturer for confirmation.

12. TESTS & WARRANTY

12.1 TESTS

Netti III XHD and Netti III XXHD are tested and have been approved for use both indoors and outdoors. The chairs are CE marked.

MAXIMUM USER WEIGHT:
200 kg for Netti III XHD & XXHD

The chairs are tested by
TÜV SÜD Product Service GmbH according to
DIN EN 12183:2014.



Netti seating system is tested for fire resistance according to: EN 1021-2:2014.



Netti III XHD & XXHD are NOT approved for being used as a seat in a car.



12.2 WARRANTY

Alu Rehab is providing you with a 5-year warranty on all frame components and on the cross-tube assembly. There is a 2-year warranty on all other CE labelled components except batteries. For batteries a 6 month warranty is provided.



Alu Rehab is not responsible for any damage resulting from inappropriate or unprofessional installation and / or repairs, neglect, wear from changes in wheelchair assemblies or instructions not approved by Alu Rehab or by use of spare parts delivered or produced by third parties. In such cases, this warranty shall be considered null and void.



This warranty is only valid when the user use, maintain and handle the wheelchair as described in the user manual.

12.3 CLAIM

If a product has developed a fault during the warranty period as result of a defect in design or manufacturing, you may forward a warranty claim.

- Claims are to be forwarded as soon as a defect is discovered and not later than 2 weeks after the defect is discovered.
- Claims are to be addressed to the sales agent of the wheelchair. Please note that sales documentation has to be filled in and signed correctly with serial number and eventually NeC number in order to document time and place of the purchase of the specific wheelchair.
- The sales agent and Alu Rehab are to decide whether a defect is covered by the warranty. The claimer will be informed about the decision as soon as possible.
- If the claim is accepted, the sales agent and the Alu Rehab representative are to decide if the product will be repaired, replaced or the customer is entitled to a reduced price.
- If a warranty claim is judged to be invalid – after careful inspection of the defect by an Alu Rehab technical specialist (defect due to wrong use and / or lack of required maintenance) you are free to decide if you want to have the defect product repaired (if possible) at your expense, or if you want to purchase a new product.



Normal wear, incorrect use or incorrect handling is not a reason for claims.

12.4 NETTI CUSTOMIZED / INDIVIDUAL ADAPTATIONS

Netti Customized / individual adaptations are defined as all adjustments that are not included in this manual. Individual adaptations made by Alu Rehab are labelled with a unique NeC number for identification.

Wheelchairs that are especially adjusted / adapted by the customer cannot keep the CE mark given by Alu Rehab A.S Norway. If the adjustments are performed by other than Alu Rehabs approved dealers, the warranty given by Alu Rehab A.S Norway will not be valid.

If there are any uncertainty about special fitting and adaptations, please contact Alu Rehab A.S.



If you have different needs than what our standard wheelchair program can cover, please contact customer service for eventually special adjustments or Netti Customized solutions.

12.5 COMBINATIONS WITH OTHER PRODUCTS

Combinations of Netti and other products not manufactured by Alu Rehab A.S: Generally in these cases, the CE mark of all the products involved will not be valid. However, Alu Rehab A.S has made combination agreements with some manufacturers about some combinations. By these combinations the CE mark and warranties are valid.



For further information, please contact your dealer or Alu Rehab A.S Norway directly.

PRODUCT RESPONSIBILITY

Netti III XHD & Netti III XXHD with different configurations of Netti equipment has been tested / risk evaluated by Alu Rehab.

Any alterations or substitutions must not be made to the wheelchair securement points or to structural and frame parts without consulting the wheelchair manufacturer Alu Rehab.

Substitutions or alterations of components from third part suppliers to Netti III XHD & XXHD requires the risk evaluation and acceptance of the product responsibility and safety for use of the wheelchair from the manufacturer that is performing the substitution or alteration.

12.6 SERVICE AND REPAIR

Information about service and repair services in your area, please contact your local dealer.



A unique identification number / serial number is found on the cross bar on the wheel frame on left side of the chair.



A spare part catalogue for the wheelchair can be obtained through your local dealer or downloaded at www.My-Netti.com



A refurbishment manual for the wheelchair can be obtained through your local dealer or downloaded at www.My-Netti.com



Information on product safety notices and product recalls are available at www.My-Netti.com



A recycling manual for the wheelchair can be obtained through your local dealer or downloaded at www.My-Netti.com

13. MEASUREMENTS & WEIGHTS

Size* seat width	Seat depth Standard**	Back rest height *** (Extender)	Total width	Weight
Netti III XHD				
500 mm	400–500 mm	500 (600) mm	740 mm	34,5 kg
550 mm	400–500 mm	500 (600) mm	790 mm	36,5 kg
600 mm	400–500 mm	500 (600) mm	840 mm	38,5 kg
Netti III XXHD				
650 mm	400–500 mm	500 (600) mm	890 mm	40,5 kg
700 mm	400–500 mm	500 (600) mm	940 mm	42,5 kg
750 mm	400–500 mm	500 (600) mm	990 mm	44,5 kg

* Measured between edges of frame tubes. For distance between skirt guards add 25 mm.

** Measured from front of seat plate to back rest hinge without cushion.
Using standard Uno back rest cushion subtract approximately 30 mm.

*** Measured from seat plate to top of back rest cushion.



The weight is including main wheels, front castors, leg supports and arm supports.
No cushion.



Recommended inflation pressure using air tyres is: 60 – 65 PSI.



Max user weight is 200 kg.



When mounting accessories such as power kit etc. the weight of the accessories must be subtracted from the max user weight.

Dealer:	
Frame number.:	
Date:	
Stamp:	



Manufacturer:

Alu Rehab AS
Bedriftsvegen 23
N-4353 Klepp Stasjon
Norway



✉ post@My-Netti.com
T: +47 51 78 62 20
my-netti.no

Distributor



Alu Rehab ApS
Kløftehøj 8
DK-8680 Ry
Denmark



info@my-netti.com
T: +45 87 88 73 00
F: +45 87 88 73 19
my-netti.dk

Distributor

Meyra GmbH
Meyra-Ring 2
D-32689 Kalletal
Germany

info@my-netti.com
T: +49 5733 922 311
F: +49 5733 922 9311
my-netti.de

Distributor

MDH Sp. zo.o.
ul. W. Tymienieckiego 22/24
90-349 Łódź
Poland

biuro@mdh.pl
T: +48 42 674 83 84
my-netti.com
