



**Netti**<sup>®</sup> *Vision*

GMDN 41630

# User Manual



**CE** This product conforms to  
2017/745/EU for medical products.

UM0114 UK 2021-06

*inspire  
joy of life*

# CONTENTS

<b>1.</b>	<b>INTRODUCTION</b>	<b>4</b>
1.1	AREAS OF USE / INDICATIONS FOR NETTI VISION	5
1.2	CONTRAINDICATIONS	5
1.3	QUALITY AND DURABILITY	5
1.4	THE ENVIRONMENT AND WASTE DISPOSAL	6
1.5	INFORMATION FOR RE-USE	6
1.6	ABOUT THIS MANUAL	7
1.7	VITAL MEASURES	7
<b>2.</b>	<b>QUICK REFERENCE</b>	<b>9</b>
<b>3.</b>	<b>DESCRIPTION</b>	<b>10</b>
<b>4.</b>	<b>FEATURES OF NETTI VISION</b>	<b>11</b>
<b>5.</b>	<b>ACCESSORIES</b>	<b>12</b>
<b>6.</b>	<b>ASSEMBLING AND ADJUSTMENT</b>	<b>13</b>
6.1	UNPACKING	13
6.2	UNFOLDING / FOLDING THE CHAIR	13
6.3	MAIN WHEEL	16
6.4	FRONT CASTORS	17
6.5	BACKREST CUSHIONS	17
6.6	SEAT DEPTH ADJUSTMENT	18
6.7	ANTI-TIP	18
6.8	SEAT CUSHION	19
6.9	LEG SUPPORTS	19
6.10	HEAD SUPPORT	22
6.11	ARM SUPPORT	24
6.12	DRUM BRAKE	25
6.13	SEAT ANGLE / TILT	26
6.14	BACKREST ANGLE	26
6.15	INSTALLATION OF HIP BELT	27

<b>7.</b>	<b>MANOEUVRING</b>	<b>28</b>
7.1	GENERAL TECHNIQUES	28
7.2	DRIVING TECHNIQUES – STEP UP –	28
7.3	DRIVING TECHNIQUES – STEP DOWN –	29
7.4	DRIVING TECHNIQUES – SLOPE – STEEP TERRAIN AND RAMPS	29
7.5	DRIVING TECHNIQUES – UP STAIRS –	30
7.6	DRIVING TECHNIQUES – DOWN STAIRS –	30
7.7	TRANSFER	31
7.8	LIFTING THE WHEELCHAIR	32
<b>8.</b>	<b>TRANSPORT</b>	<b>33</b>
8.1	TRANSPORT OF UNOCCUPIED WHEELCHAIR	33
8.2	TRANSPORT IN CAR	33
<b>9.</b>	<b>MAINTENANCE</b>	<b>34</b>
9.1	MAINTENANCE INSTRUCTIONS	34
9.2	CLEANING AND WASHING	34
9.3	SPARE PARTS	35
9.4	LONG TERM STORAGE	35
<b>10.</b>	<b>TROUBLESHOOTING</b>	<b>36</b>
<b>11.</b>	<b>TESTS &amp; WARRANTY</b>	<b>37</b>
11.1	TESTS	37
11.2	WARRANTY	37
11.3	CLAIM	38
11.4	NETTI CUSTOMIZED / INDIVIDUAL ADAPTATIONS	38
11.5	COMBINATIONS WITH OTHER PRODUCTS	39
11.6	SERVICE AND REPAIR	39
<b>12.</b>	<b>MEASURES &amp; WEIGHT</b>	<b>40</b>
12.1	OVERALL DIMENSIONS IN MINIMAL USER POSITION	40
12.2	TILT, RECLINE AND FOOT SUPPORT DIMENSIONS	42
12.3	TURNING RADIUS	43

# 1. INTRODUCTION

**Netti Vision is a comfort wheelchair meant for both indoor and outdoor use.**

In Alu Rehab we believe that wheelchairs should be chosen based on a thorough assessment focusing on the needs of the user and demands from the environment.

Therefore it is important to know about the possibilities and restrictions of the wheelchair. Netti Vision is a wheelchair designed for users with the need for comfort and relief. The combination between the seating system and the ergonomically solutions in the frame construction, offers many possibilities for adaptation and adjustments for long time seating.

The wheelchair is constructed for indoor and outdoor use, and offers the possibility to vary the sitting position from activity to rest using tilt and recline functions.

**Max user weight: 100 kg.**



**Specifications varies between countries.**

## **User Manual on web**

For enhanced readability (advantageous for users with visibility challenges) please find this user manual on our webpage: [www.my-netti.com](http://www.my-netti.com)  
– downloads – manuals – user manual Netti Vision.

Latest user manual updates, product safety notes and other product informations like recalls etc. will be published on our webpage: [www.My-Netti.com](http://www.My-Netti.com)





## 1.1 AREAS OF USE / INDICATIONS FOR NETTI VISION

Netti Vision is a foldable multi-function wheelchair created for only attendant handling, for partially or fully immobile youth and grown up persons with physical and / or mental disabilities. These disabilities may have multiple causes.

Netti Vision has an adjustable seat and back angle, thus facilitating for the user change of position, mobilization or posture correction (stabilization), wherever the following functional impediments with their multiple possible causes are present:

- limited or lacking mobility
- limited or lacking muscle power
- limited movement range
- lacking or limited trunk and body stability
- hemiplegia
- rheumatic-type disorders
- craniocerebral injuries
- amputations
- other neurological or geriatric disorders.

## 1.2 CONTRAINDICATIONS

Netti Vision is not suited for persons with a strongly enhanced muscular spasticity. In this case we recommend the Netti Dynamic System, which offers a frame construction that follows the movement pattern of the user. Ignoring this advice could in unfavorable circumstances lead to the deformation or fracture of metal parts in the area of the back tube, the legrests or the armrests.

## 1.3 QUALITY AND DURABILITY

Netti Vision has been tested at TÜV SÜD Product Service GmbH in Germany following the European Standard EN 12183:2014.



As manufacturer, Alu Rehab A.S. evaluates the test to be equal to 5 – 6 years of normal use of the chair. The disability of the user as well as the level of maintenance done foremost decides the durability of the wheelchair. Thus, the durability will vary depending on these two factors.

In normal use Alu Rehab A.S. expects the service life to be 5 – 6 years. In practice the service life will depend strongly on external factors including disability of the user, environment and whether regular maintenance has been carried out.

## 1.4 THE ENVIRONMENT AND WASTE DISPOSAL

Alu Rehab and its suppliers wish to protect the environment.



This means:

- That we avoid using environmentally harmful substances and processes to the greatest extent possible.
- That Alu Rehab's products are ensured a long service life and a high degree of flexibility – to benefit the environment and economy.
- That all packaging can be recycled.
- That the wheelchair was designed to be separated into its component materials – to make recycling easier.



**Contact your local recycling agent to get correct information how to handle in your area.**

## 1.5 INFORMATION FOR RE-USE

All products from Alu Rehab are designed to require low maintenance and easy service. All products can be adapted for re-use by an authorised dealer. In order to guarantee performance and safety, Alu Rehab recommends the following tests prior to any re-use.

Please examine the following components for function, integrity etc. and replace parts as necessary:

- Wheels (tyre tread)
- Wheelchair frame
- Cushions
- Hubs
- Brake function
- Directional stability of wheels
- Bearings
- Folding mechanisms
- Leg supports
- Arm supports
- Head support
- Recline / tilt function
- Push bar
- Anti-tip

Please also note the content of chapter 9.2 Cleaning and washing.

### RECYCLING

All wheelchair components can be split into separate one material pieces for easy recycling; exception is the armrest with metal frame integrated in PUR foam which has to be cut.

## 1.6 ABOUT THIS MANUAL

In order to avoid damages while using the Netti Vision wheelchair, please read this manual carefully before starting to use the chair.

Please note: Date for publishing this manual is noted on the bottom of each page.



For visually impaired people, manuals and catalogues can be downloaded at [www.alurehab.com](http://www.alurehab.com)

## 1.7 VITAL MEASURES

Netti Vision is a comfort wheelchair designed for both outdoor and indoor use.



Specifications varies between countries.

**TOTAL WEIGHT: 27 KG**  
(400 mm seat width chair)

**SEAT WIDTH:**

400 mm\*



\* Assortment varies between markets.

**SEAT DEPTH:**  
(From backrest cushion to front of seat plate)

350, 375, 400, 425 mm



**SEAT HEIGHT:**  
(From floor to top seat plate)

385 mm\*

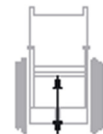

\* 16" drum brake wheels.

**BACKREST HEIGHT:**

450 mm



Specification	min.	max.
Overall length with leg support (WB 399)	865 mm	865 mm
Overall length without leg support	700 mm	700 mm
Height without headrest	765 mm	980 mm
Overall width	550 mm	–
Reversing width	628 mm	–
Folded length	658 mm	–
Folded width	283 mm	–
Folded height	840 mm	–
Total mass with cushions	27,0 kg	27,0 kg
Mass heaviest part	17,0 kg	–
Static stability uphill slope without anti-tip	3° *	19°
Static stability uphill slope with anti-tip	19°	19°
Static stability downhill slope	11°	19°
Static stability sideways slope	12°	15°
Seat plane angle	–2°	30°
Effective seat depth	350 mm	425 mm
Effective seat width	350 mm	450 mm
Seat surface height at front	380 mm	–
Backrest angle	90°	110°
Backrest height	453 mm	400 mm
Foot plate to seat distance	222 mm	400 mm
Leg to seat surface angle	90°	210°
Arm support to seat distance	39 mm	340 mm
Front location of arm support structure	338 mm	–
Horizontal axle location	0 mm	0 mm
Minimum turning radius	638 mm	–

Measured with std. 16" & 6" wheels.

## 2. QUICK REFERENCE

The content of this page is a summary of the whole manual. It gives you a brief introduction to the use and care of the Netti Vision wheelchair.

 **The quick reference is not a replacement for the manual, only reminder / check list.**

- Unpack the wheelchair (Chapter 6.1)
- Fold out the seat plate and mount the pushbar.
- Mount the seat cushion (Chapter 6.8)
- Mount the backrest cushion (Chapter 6.5)
- Mount the leg supports (Chapter 6.9)
- Mount the head support (Chapter 6.10)
- Adjust the wheelchair to the user.
- Mount accessory. (See chapter 5 for more information. Mounting descriptions will accompany the accessory.)

 **For troubleshooting, see chapter 10. For mounting and adjustments see chapter 6.**

### ANTI-TIP

Correctly fitted, the anti-tip will secure the chair from tipping backwards. We strongly recommend use of the anti-tips at all times.

 **Drive carefully!**

 **Be aware that friction against pushrims can create a warm surface.**

 **Surface temperature of metal parts in frame structure might increase when exposed to direct sunlight.**

 **Salt water can increase risk of corrosion further precautions related to environmental conditions not needed.**

 **The anti-tips should always be used for the safety of the user.**

 **When the chair is tilted rearwards, the anti-tips and brakes must always be in use.**

 **Be sure to lock all handles properly.**

 **Watch out for pinching danger when folding and unfolding, tilting, reclining and all other adjustment movements.**

 **Never stand on the foot plates due to risk of tipping forwards.**

 **Never lift the wheelchair by the leg supports, arm supports or head support.**

 **Product configuration may vary between different countries.**

 **Illustrations may differ from the delivered product.**

 **If in doubt – contact your dealer!**

## 3. DESCRIPTION

### Standard version\*

1. Head support
2. Angle and depth adjustment for head support
3. Head support bracket
4. Push handle
5. Release handle
6. Main wheel
7. Anti-tip
8. Brakes
9. Front castors
10. Front fork
11. Foot plate
12. Calf support
13. Calf support bracket
14. Angle adjustable foot support
15. Seat cushion
16. Arm support with pad
17. Back cushion
18. Push bow shaped tube
19. Release handle Tilt
20. Release handle Back

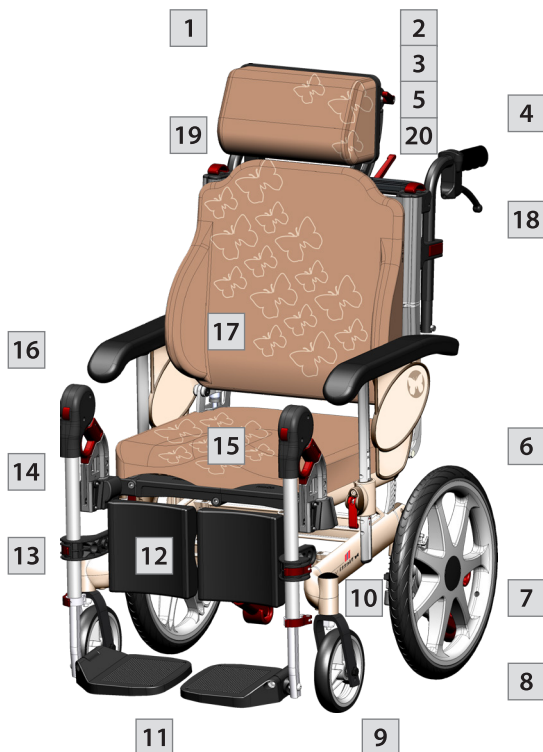

**i** If any of these parts are missing, please contact your dealer.

**i** Product configuration may vary between different countries.

## 4. FEATURES OF NETTI VISION

### STANDARD

#### SEAT

- Pressure distributive cushion
- Tilt  $-2^{\circ}$  to  $+30^{\circ}$
- Adjustable depth of 75 mm

#### WHEELS

- 16" puncture proof main wheels with fixed axle
- 6" puncture proof front castors with quick release axle

\* Standard main wheels may vary between countries.

#### BACKREST

- Angle:  $90^{\circ}$  to  $110^{\circ}$
- Height: 455 mm
- Netti Nordic Back
- Push bar
- Push handles

#### FOOT SUPPORT

- Angle adjustable foot support
- Height and angle adjustable foot plates
- Height and depth adjustable calf supports
- Removable

#### ARM SUPPORT

- Height adjustable
- Removable

#### HEAD SUPPORT

- Height, depth and angle adjustable
- Removable

### ACCESSORIES

#### SEAT

- Pressure distributive cushions

#### HIP BELTS

- 2 types of hip belts

#### BACKREST

- Different backrest cushions

#### HEAD SUPPORT

- Different head support models

## 5. ACCESSORIES

### SEAT CUSHIONS

Many to choose from.  
Please contact your dealer.



### HEAD SUPPORT

Support D Medium  
Support C Large  
Support A Side support  
Support B Small



### BACKREST CUSHIONS

Many to choose from.  
Please contact your dealer.



### HYGIENE COVER

Protects the core of the  
head support.



### RECOMMENDED SEAT CUSHION

#### NETTI CONTOUR

Anatomic shaped  
seat cushion with  
high pressure  
distribution properties  
and low seat height.



#### HIP BELT

With car lock.



### RECOMMENDED BACKREST CUSHION

#### NETTI NORDIC

Pressure distribution  
and side support  
properties with visual  
design elements to  
make positioning easy.  
Multilayer back specially  
fitted to be used together  
with Netti Vision.



#### BP EVOFLEX BELT

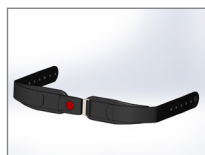

#### NETTI FLIP

Simple back padding.  
Provides room for  
movement.





# 6. ASSEMBLING AND ADJUSTMENT

## 6.1 UNPACKING

1. Unpack all the parts, and check that everything is there according to the packing list.
2. Unfold the chair (Chapter 6.2).
3. Check and adjust the seat depth (Chap. 6.6).
4. Mount the backrest cushion(Chapter 6.5).
5. Mount the seat cushion (Chapter 6.8).
6. Mount the leg supports (Chapter 6.9).
7. Mount the head support (Chapter 6.10).
8. Mount any accessories (Chapter 5).

### Weight of components:

Main wheels:	2,0 kg each
Anti-tip:	0,4 kg each
Front castors:	0,6 kg each
Foot support angle adj.:	2,3 kg each
Seat cushion:	0,7 kg
Head support A:	1,0 kg
Head support C:	1,0 kg
Head support D:	0,9 kg

### Mass heaviest part when transporting:

Frame with wheels as shown on the picture right side: 19,1kg.

## 6.2 UNFOLDING / FOLDING THE CHAIR

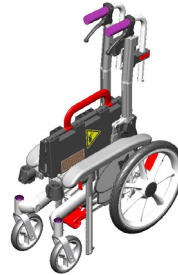

The chair comes folded with wheels backrest and arm supports pre-mounted.

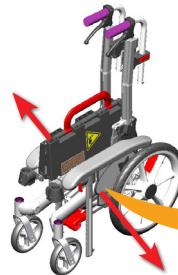

Pull side frames apart.



Grab red handle, and push seat plate down until it clicks into position.

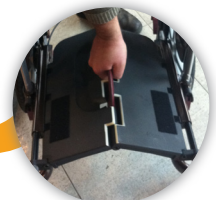
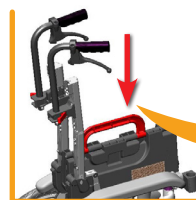

Push red knob until cross bar clicks into position.

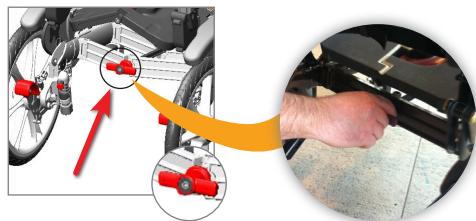

To attach the cross bar to the wheelchair be aware that the red lockers are adjusted in the rearwards position.

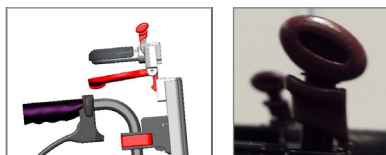

Unlock push handles by opening red clamp, and turn rearwards into position.



Slide the triangular part of the cross bar into the triangular shank of the back on both sides.

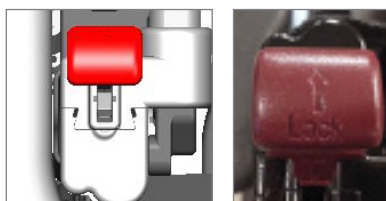

Slide push bar with head support and release handles into slot on top of backrest tubes on both sides.



After move the lockers frontwards back to the "Lock" position. If you hear the "click" sound on both sides the crossbar is locked. The head rest can now be mounted.

 **Work carefully to avoid getting pinched when parts are slid into one another and when handles are opened and locked.**



Swing head support up into position.

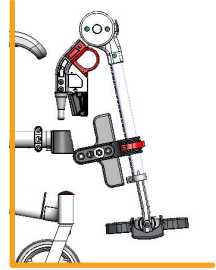

Place backrest onto velcro.

Place foot support pin into lock in front of seat frame, and swing into position.

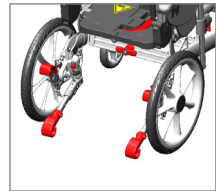
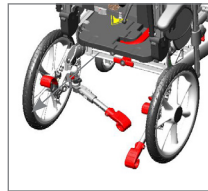

Fold bottom flap up then top flap down, to fix backrest.

Grab anti tip and swing into position (pointing rearwards).



Follow instructions under cushion to place it correctly.

### Dismounting the cross bar

When folding the chair, dismount the cross bar like this:

Before you take the cross bar off make sure the tilt and recline functions are in their neutral positions: (0 degrees recline, and -2 degrees tilt).

As a first step the head rest should be removed. After you must lift on both sides the lower part of the red locker with two fingers and pull the locker backwards.



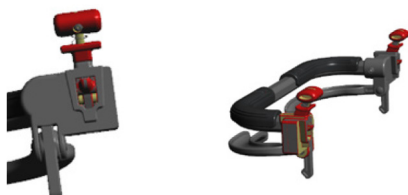

When both lockers are in the unlocked position the triangular upper part of the crossbar is now free to lift out of the shank of the back. With smooth forces you can lift the crossbar with two hands upwards until you have separated it.

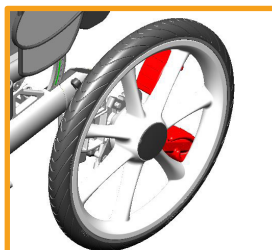

### 6.3 MAIN WHEEL

The main wheel comes pre-mounted and fixed to the frame with a bolt.



 Sand and sea water (salt used for gritting in the winter) can damage the bearings of the main wheels and front castors. Clean the wheelchair thoroughly after exposure.

## 6.4 FRONT CASTORS

### Removing:

- Press the release button on the top of the front fork, and pull down.

### Mounting:

- Lead the quick release axle into the bearing house. Pull the fork slightly to ensure that the fork is fully locked.

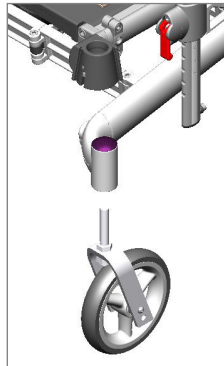
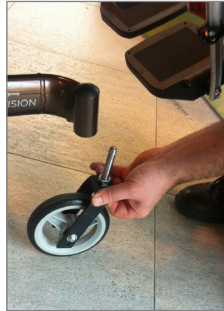

## 6.5 BACKREST CUSHIONS

Backrest cushions are fixed onto the wheelchair using velcro.



The backrest comes with 6 adjustable straps for optimal individual fitting.



It is imperative to correctly set-up the cushion in order to ensure good seating comfort



The cushion covers are washable and thereby reusable. Follow the instruction on the back of the cushion for correct maintenance and washing of the cushion.

## 6.6 SEAT DEPTH ADJUSTMENT

- Seat depth is adjusted at the front by loosening the screws on each side.

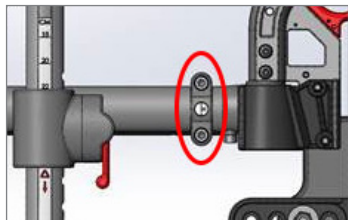

- Pull out extension pieces attached to the seat plate on each side to required position. Seat plate follows adjustment.



Make sure to lock bolt on both sides.



5 mm Allen-key.

## 6.7 ANTI-TIP

Netti Vision is on both sides equipped with an anti-tip. These have a swing away mechanism which is easy to operate. Pull the red knob with one hand outwards and swing the anti-tip with the other hand frontwards. The ending and locked position is indicated by a “click” sound.

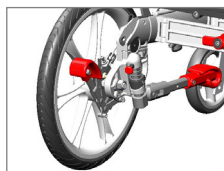

### Adjusting the height of the anti-tip

The anti-tip can be adjusted in height by loosening the screw close to the hinge point.

- Unfix the screw and pull or push to required position.

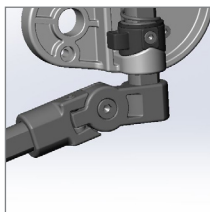

4 and 6 mm Allen-keys.



The anti-tip should always be used for the safety of the user.



## 6.8 SEAT CUSHION

The seat cushion is fixed on the wheelchair with Velcro.



It is very important to place the cushion in the wheelchair before use.



The cushion cover is washable and reusable. Follow the instruction on the back of the cushion for correct maintenance and washing of the cushion.

## 6.9 LEG SUPPORTS

The elevating leg support is angle adjustable, swingable and removable.

It comes with height and depth adjustable calf support. The foot plates are hinged, and can be angled in fixed positions. As a standard the foot plates come with a locking bolt which makes the plates stronger.

### Legrest elevating adjustment instructions

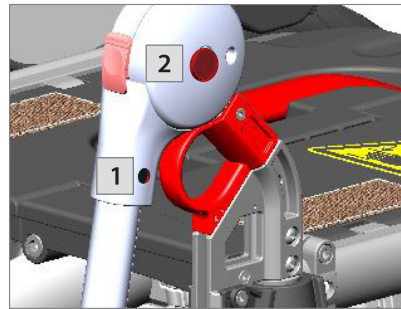

The legrest of Netti Vision is designed for easy operating and avoids potential squeeze hazard.

There are **2 red knobs** to operate when elevating the legrest.

**Knob 1** is the square one at the front area of the upper legrest and **knob 2** is a round one at the side.

In the standard position the legrest is locked at 97°. From here you can elevate furthermore up to 210° in addition with **knob 1**.

To elevate below the standard lock position down to 90° you need to use **knob 2**.

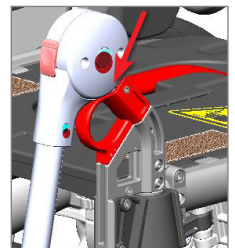

You can operate **knob 1** with one hand if you want to elevate the leg rest front wards in height. Therefore you have to push the knob inwards with your thumb while you lift (with the other fingers) the legrest frontwards and highwards.

To elevate the leg rest beneath the standard locking position you need to press the round knob (**knob 2**) with one finger inwards and with the other hand you have to push the square knob (**knob 2**) to unlock the legrest and get it down.

### Foot plate height adjustment – operating instructions

The foot plates are step less height adjustable. Unfix the adjustment screw so that the adjustment bar moves freely. Adjust the foot plate to required height, then tighten the screw.





### Foot plates with red lock – operating instructions

The foot plates come with a locking bolt in red meant to offer a higher stability to the foot plates.

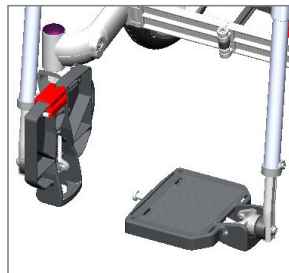
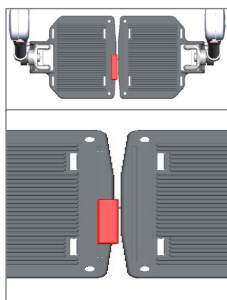
To lock the foot plates pull the plastic lock on the right foot plate and place the lock over the bolt on the left foot plate.



To release the foot plate pull the plastic lock frontwards and lift the right foot plate up.

-  While making the adjustment there must be no load on the foot plates.
-  For outdoor use, there should be a clearance of 4 – 5 cm between the foot plate and the ground.
-  Never stand on the foot plates due to the risk of tipping forward.

### Foot plate – angle adjustment

Unfix the screw as shown by using a 5 mm Allen-key. Adjust the foot plate to the required angle and tighten the screw.

-  5 mm Allen-key.



## Adjusting the calf support

### To adjust in height:

- Release clamp on foot support stem.
- Find the required position.
- Tighten clamp on foot support stem.



### To adjust in depth:

- Release pad by using a 13 mm spanner.
- Find the required position
- Fix screw.



5 mm Allen-key.



## Removing the leg support

- Pull the red release handle in hinge point.
- The leg support can now be lifted up in any position.

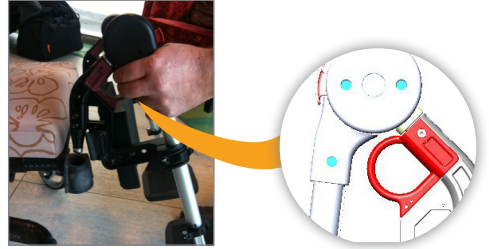

Never stand on the foot plates!



Never lift the wheelchair by the leg supports.

## 6.10 HEAD SUPPORT

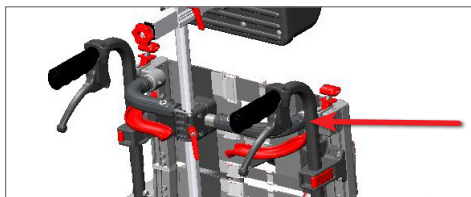

Netti Vision has a stabilizing cross bar at the upper part of the back tube carrying the head support bracket and the operating handles for tilt and recline. If there is any reason to fold the chair (transport or storing) the cross bar can be dismounted. After you have done this, it is for security reasons not more possible to tilt and recline the chair.

When mounting the cross bar at the wheelchair the correct mounting is indicated with a “click” sound.

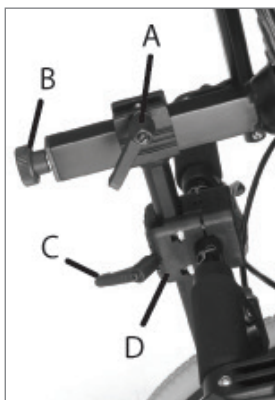
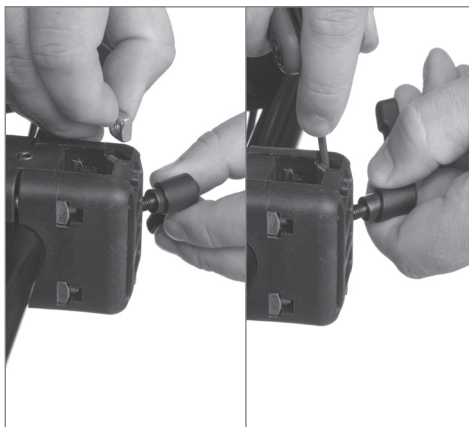

A – Lever for depth adjustment  
 B – Wheel for angle adjustment  
 C – Lever for height adjustment  
 D – Head support bracket

- Place the squared nut in the slot of the head support bracket as shown above.
- Place the head support in the head support bracket.
- The height and the depth of the head support is set to the required positions and tightened.



The head support bracket is fixed by tightening the four screws two by two diagonally so the bracket is fixed with the same strength divided on the four screws.

#### Adjusting the head support in depth:

- Release the locking lever on top of the vertical bar (A).
- Adjust the head support and fix it in required position.

#### Adjusting the head support in height:

- Release the locking lever on the head support adapter (C).
- Adjust the head support and fix it in required position.

#### Adjusting the head support in angle:

- Release the adjustment wheel at the rear of the horizontal bar (B).
- Adjust the head support and fix it in required position.

#### Adjusting the head support sideways:

- The head support adapter can be moved both to the right and left, giving the possibility to accommodate special needs for head support.
- Untighten the four screws holding the adapter together.
- Move the adapter to the required position and fix the adapter by tightening the screws diagonally.



**Remember to release the levers when adjusting the head support.**



**If the head support stand does not fit the bracket perfectly, the bracket is probably fixed too tight or unevenly.**



**After fitting the head support fix it properly by tightening the little set screw in the centre on top of the head support bracket using an Allen-key.**



**If the head support seems to short in height, it can be turned 180° by releasing the adjustment wheel at the rear of the horizontal bar (B).**

## 6.11 ARM SUPPORT

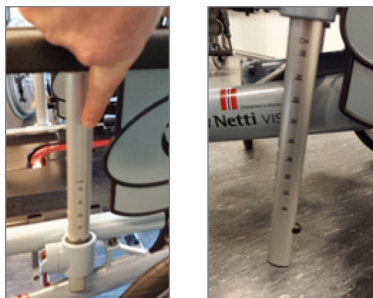

### Mounting the arm support:

- Release lock handle.
- Push arm support straight down in a vertical direction into the insert sleeve.
- Fix the nut to the vertical profile below the sleeve at a maximum adjusted arm support height.

### Dismounting the arm support:

- Remove the nut limiting the height.
- Release the lock handle.
- Pull the arm support in a vertical direction up out of the sleeve.

### Adjusting the height of the arm support:

- Lift up the release handle on the arm support.
- Raise or lower according to your needs.
- Tighten the release handle.



Placing the arm support in lower position allows sideway transfer.

At the end of the vertical bar there is a black nut which is to be placed in another position if you want to avoid adjusting the arm rest above a specific point (your required position).



For security and stability reasons do not lift the whole chair with a person in it. In case you do so, the black nuts will avoid the of armrest bar sliding out of the bracket if the locking mechanism is not tighten.



Please be aware while mounting that there is a left-side and a right-side arm support.



Never lift the chair holding onto the arm supports.

## 6.12 DRUM BRAKE

### Operating and applying the brakes

Netti Vision comes standard with pedal parking brakes.

For activating and locking the parking brake push down the the red brake pedal.

- **To activate:** Press down.
- **To de-activate:** Pull up.

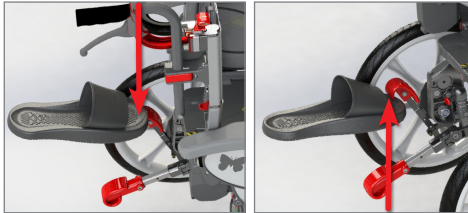

 **Don't leave the user in the wheelchair without activating the parking brake.**

Netti Vision comes with hand-and-arm operated hub brakes for attendant as an option, to allow regulation of speed on hills and whilst manoeuvring the chair. These are located on the push handles.

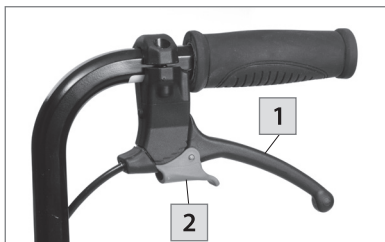

- To apply the brakes, pull the brake levers (1) evenly and smoothly towards handle and bring the wheel-base to a stop.

**If the brake doesn't brake properly:**  
To adjust the wire on one or both sides, adjust the foot screw 2 – 4 rounds out. Then recheck the brakes.



**If the wire is too loose:**  
Adjust the foot screw all the way in. Tighten the wire by loosening the wire clamp before pulling the wire further through it. Tighten the wire clamp, and adjust the foot screw out again.



 1 pc 10 mm open-end spanner.

 **Tighten lock nut when finished adjusting.**

## 6.13 SEAT ANGLE / TILT

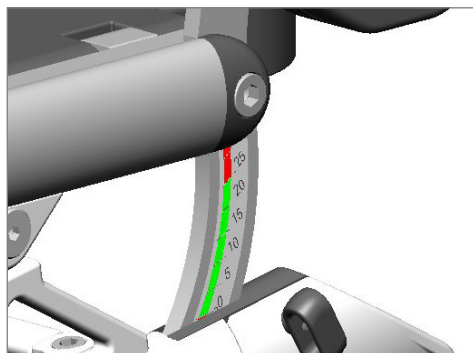

Netti Vision has a rear – and front wards tilt function (angle adjustable seat frame). To get to know which degree of angle actually is adjusted you can have a look at the control scale at the rear part.

The number just above the frame whole indicates the actual angle (here it shows 0°).

**Red color up:** 25 to +30 degrees rearwards

**Green color:** 0 to +25 degrees rearwards

**Red color down:** 0 to –2 degrees frontwards

The seat angle is regulated using the left release handle on the push bow. The seat unit can be tilted from –2° to +30°.

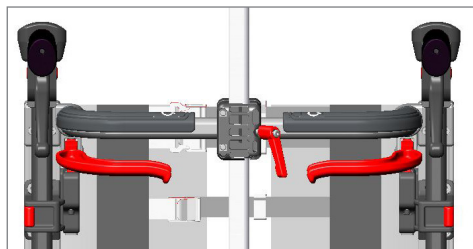

## 6.14 BACKREST ANGLE

Netti Vision has a reclining back (angle adjustable). To get to know which degree of angle actually is adjusted you can have a look at the small control window at the rear part. There you will find a number indicating the actual degree (here it shows 20°).

The backrest angle is regulated using the right release handle on the push bow.

The angle can be regulated from 90° to 110°.



The release handles have the following labels:



Tilt



Recline



**Risk for tipping.**  
Check the position of anti-tip.



The seat and backrest angle must not be adjusted without using the anti-tips.

## 6.15 INSTALLATION OF HIP BELT

Netti Vision is delivered prepared for installation of hip belts.

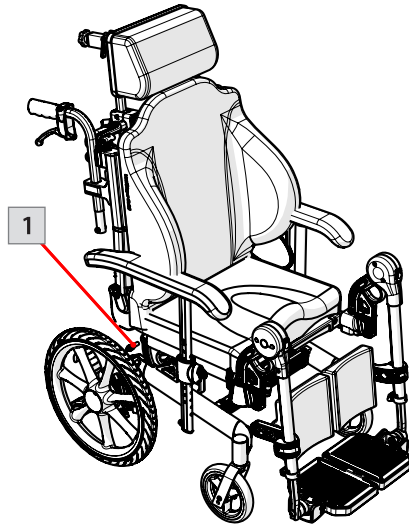

Replace frame screw (1) with belt bolt, delivered with the hip belt kit.

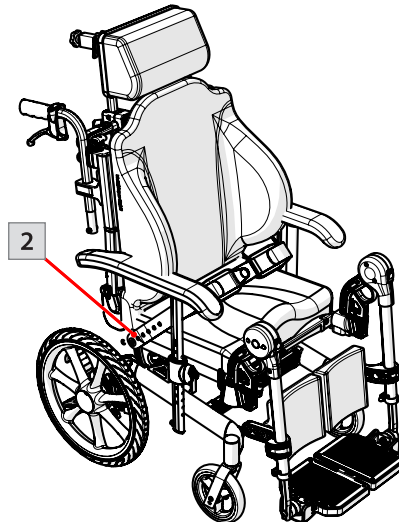

Insert belt to the belt-bolt – in the correct belt hole (2) adjusted for the user.  
Fix the belt with washer and e-lock or nut delivered with the belt kit.



## 7. MANOEUVRING

### 7.1 GENERAL TECHNIQUES

The weight and balance of the chair influences the manoeuvring qualities of the wheelchair. The weight, size and sitting position of the user are also influencing factors. The position of the wheels will in addition influence the manoeuvring qualities. The more weight placed over the main wheels, the easier it is to manoeuvre. If heavy weight is placed over the front castors, the chair will be heavy to manoeuvre.

#### Companion:

If the user is left alone in the wheelchair, always lock the brakes and check that the anti-tips are turned down.

#### Parking:

Increase the underneath support of the wheelchair by moving the chair about 10 cm rearwards making the front castors turn forward.

### 7.2 DRIVING TECHNIQUES – STEP UP –



#### Companions, drive up a step forwards:

- Check that the anti-tip is de-activated.
- Angle the wheelchair backwards.
- Balance the chair on the mainwheels and push it forward until the front castors are on the step.
- Lift the push handles while pushing the chair onto the step.



**Remember to activate anti-tip after curb climbing.**

#### Companions, drive up a step backwards:

- Check that the anti-tip is de-activated.
- Pull the chair backwards next to the step
- Angle the wheelchair backwards, moving the front castors slightly up in the air.
- Pull the wheelchair up the step and go backwards long enough to put down the front castors on the step.



**Activate anti-tip.**



### 7.3 DRIVING TECHNIQUES – STEP DOWN –

#### Companions, drive down a step forwards:

- Check that the anti-tip is de-activated.
- Place your hands with a firm grip on the push handles, and angle the wheelchair backwards, moving the front castors slightly up in the air.
- Drive carefully down the step and angle the wheelchair forward putting the front castors back on the ground.

 Turn the anti-tip downwards.

#### Companions, drive down a step backwards:

- Check that the anti-tip is de-activated.
- Move the wheelchair backwards to the step.
- Drive carefully down the step and move the wheelchair backwards on the main wheel until the front castors have come away from the step.
- Put the front castors down on the ground.

 Activate anti-tip.

### 7.4 DRIVING TECHNIQUES – SLOPE – STEEP TERRAIN AND RAMPS

Important advise for driving down and up hill avoiding the risk of tipping.



 Use rearward tilt.

 Avoid turning the wheelchair in the middle of a slope.

 Always drive as straight as possible.

 It is better to ask for assistance than taking risks.

## 7.5 DRIVING TECHNIQUES – UP STAIRS –



**Never use escalators.**

### **With assistance, backwards:**

- Check that the anti-tip is de-activated.
- Pull the wheelchair backwards to the first step of the stairs.
- Angle the wheelchair backwards on the main wheels.
- Pull the wheelchair slowly up the stair, one step at the time keeping the balance on the main wheel.
- Reaching the top of the stair, pull the wheelchair backwards far enough to put the front castors safely down on the floor.



**Activate anti-tip.**



**If two companions are present, one person can assist lifting in the front of the frame.**



**Do not lift the wheelchair holding onto the foot supports.**



**Do not lift the wheelchair holding onto the arm supports.**



**The companions should use the strength in their legs carrying the chair, avoiding unnecessary stress on the back.**

## 7.6 DRIVING TECHNIQUES – DOWN STAIRS –



**Never use escalators.**

### **With assistance, forwards:**

- Check that the anti-tip is de-activated.
- Drive the wheelchair forward to the first step of the stairs.
- Angle the wheelchair backwards on the main wheels.
- Have a firm grip on the push handle, and keep the balance on the main wheel taking one step at the time.
- Reaching the bottom of the stair, put the front castors safely down on the floor.



**Activate anti-tip.**



**If two companions are present, one person can assist lifting in the front of the frame.**



**Do not lift the wheelchair holding onto the foot supports.**



**Do not lift the wheelchair holding onto the arm supports.**

## 7.7 TRANSFER

Techniques for transferring to / from the wheelchair should be practiced well with the persons involved. Here, we give some important advices for preparation of the chair:

### With or without companion – sideways.

#### Before transfer:

- The wheelchair should be placed as close as possible to the destination of the transfer.
- Pull the wheelchair backwards 5 – 10 cm in order to make the front castors turn forward.
- Lock the brakes.
- Remove foot support and arm support in lower position on the side of the transfer.



### Using a lift.

#### Before transfer to chair:

- Tilt the chair back.
- Remove the head support.
- Remove the foot supports.
- Open the backrest angle slightly.
- Replace the components when transfer is finished.

### With or without companion – forwards.

#### Before transfer:

- The wheelchair should be placed as close as possible to the destination of the transfer.
- Pull the wheelchair backwards 5 – 10 cm in order to make the front castors turn forward.
- Lock the brakes.
- Tilt chair forward.



**Never stand on the foot plates.**

## 7.8 LIFTING THE WHEELCHAIR

- The wheelchair should be lifted in the frame only.

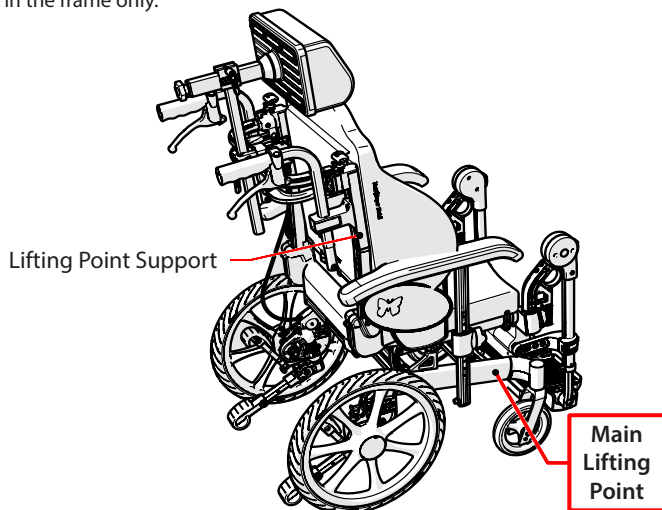

-  **Lifting Point label:**

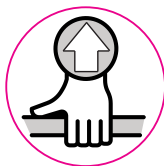

-  **Never lift the wheelchair by the leg supports or arm supports. They may detach and the user may fall out of the chair.**



-  **Don't lift the wheelchair with a user in it.**

## 8. TRANSPORT

### 8.1 TRANSPORT OF UNOCCUPIED WHEELCHAIR

- Remove the seat and back cushion.
- Remove the leg supports.
- Remove the head support.
- Push the armrests down.
- Remove the push bar from the backrest tubes by unlocking the red knobs – see page 16 for details.
- Unlock and pull the red knob under the seat plate for the crossbars to fold.
- Lift the red handle in the middle of the seat plate.

Folded chair ready to be transported:

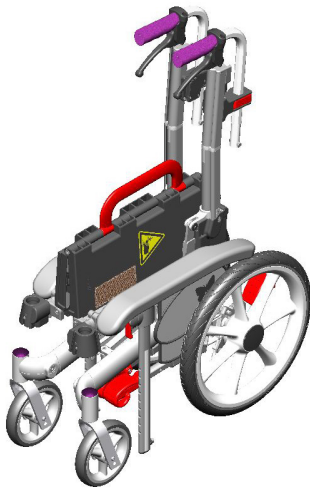

For unfolding please study the pictures and descriptions on page 13 – 16.

The chair folds and can be lifted into a transport vehicle.

Be sure to fix the chair and its parts in the vehicle in a way they cannot fly around and be of danger for others.

Mass heaviest part is the frame with wheels – as shown on the picture – 19,1 kg.

### 8.2 TRANSPORT IN CAR



Netti Vision wheelchair is **NOT** intended and **NOT** approved to be used as seat in vehicles. The user must always transfer to a car seat and be secured by car safety belts.



Labels signalling this is fixed to the frame.

## 9. MAINTENANCE

### 9.1 MAINTENANCE INSTRUCTIONS



You as a user of the wheelchair (and your attendants and family) are responsible for the everyday maintenance of the chair. Clean it regularly. Do the maintenance to assure safe and long time reliable functions and hygienic appearance.

Frequency	Weekly	Monthly
Check defects / damages e. g. breakage / missing parts	X	
Washing of wheelchair		X
Oiling of bearings with bicycle oil*		X
Washing of cushions		X
Check anti-tip function		X
Check brake adjustment		X
Check tilt and recline function		X
Check tyre wear		X
Check arm support adjustment		X
Check foot support adjustment		X

### 9.2 CLEANING AND WASHING

1. Remove cushions before washing the wheelchair.
2. Clean the frame using water and a rag.
3. We recommend using soft soap.
4. Rinse the wheelchair well using clean water to remove all the soap.
5. Use methylate spirit to remove any dirt left.
6. Clean cushions and covers according to instructions printed on cushions.

#### NETTI CUSHION CLEANING PROCEDURES

CORE	
Washing	Hand wash 40° C
Disinfection	Virkon S
	Auto clave 105° C
Drying	Squeeze
	Air dry standing edgewise
OUTER COVER	
Washing	Machine wash 60° C
Drying	Tumble dry max. 85° C

## DISINFECTION OF THE WHEELCHAIR

Remove cushions.

See separate washing instruction above:

Wipe disinfection: use a soft rag wetted with Hydrogen peroxide or technical alcohol (isopropanol) and wipe the whole chair clean.

Hydrogen peroxide recommended:  
NU-CIDEX "Johnsen and Johnsen".

 **Check / re-adjust screws and nuts at regular intervals.**

 **Sand and sea water (salt used for gritting in the winter) can damage the bearings of the front castors and main wheels. Clean the wheelchair thoroughly after use.**

\* As a rule of thumb, use oil on movable parts and all bearings. Alu Rehab recommends use of ordinary bicycle oil.

## 9.3 SPARE PARTS

The Netti chairs are built of modules. Alu Rehab carries stock of all parts and is ready to supply these on short notice. Necessary instructions for mounting will follow the parts.

Parts to be handled by user are defined in spare part catalogues that can be downloaded at [www.My-Netti.com](http://www.My-Netti.com).

These parts can, if needed, also be removed and sent to manufacturer / distributor upon request.

 **Parts related to wheelchair frame construction must be handled by manufacturer or authorized service facility.**

 **If defects or damages occur, please contact your dealer.**

 **Original paint for repair of scratched, can be ordered from Alu Rehab.**

## 9.4 LONG TERM STORAGE

If the wheelchair is stored for longer time – (longer than 4 months) no particular actions are needed. We recommend that the chair is cleaned before it is stored. Before starting using it again, the maintenance instructions must be followed.

We recommend to replace the head support if the chair is given to a new user.

## 10. TROUBLESHOOTING

Symptom	Reason / Action	Reference in manual
The wheelchair is going askew	<ul style="list-style-type: none"> <li>The main wheel hubs might be incorrectly mounted.</li> <li>One of the brakes might be too tight.</li> <li>The user is sitting very askew in the chair.</li> <li>The user might be stronger on one side than the other.</li> </ul>	6.2 6.13
The wheelchair is heavy to manoeuvre	<ul style="list-style-type: none"> <li>The main wheel hubs might be incorrectly mounted.</li> <li>Clean the front castors and forks for dirt.</li> <li>Too much weight over the front castors.</li> </ul>	6.2
The wheelchair is hard to turn	<ul style="list-style-type: none"> <li>Check that the front castors are not fixed too hard.</li> <li>Clean the front castors and forks for dirt.</li> <li>Check, that the front castors are placed in correct position.</li> </ul>	6.3 6.3
The brakes are not functioning well	<ul style="list-style-type: none"> <li>Adjust the brake.</li> </ul>	6.13
The wheelchair feels "shaky"	<ul style="list-style-type: none"> <li>Check screws and adjustment points in general</li> </ul>	



Please contact your dealer for information about authorized service facilities that can give support if solution is not reached in this form.



When in need of spare parts, please contact your dealer.



When making changes affecting frame construction, contact dealer / manufacturer for confirmation.



# 11. TESTS & WARRANTY

## 11.1 TESTS

Netti Vision is tested for both indoor and outdoor use.  
The chair is CE marked.

Netti Vision is tested and fulfills the wheelchair requirements EN 12183:2014, tested and verified by TÜV SÜD.

Netti Vision is tested to ISO 7176-8 static, impact and fatigue strength.

All components and assemblies in Netti Vision fulfill the requirement of low ignitability quality according to EN 1021-1 & 2:2006.



## 11.2 WARRANTY

Alu Rehab is providing you with a 5-year warranty on all frame components and on the cross-tube assembly. There is a 2-year warranty on all other CE labelled components except for batteries. For batteries a 6-month warranty is provided.

**⚠️ Alu Rehab is not responsible for any damage resulting from: inappropriate or unprofessional installation and / or repairs, neglect and missing maintenance, wear from changes in wheelchair assemblies performed by institutions not approved by Alu Rehab or by use of spare parts delivered or produced by third parties. In such cases, this warranty shall be considered null and void.**

**⚠️ This warranty is only valid when the user use, maintain and handle the wheelchair as described in the user manual.**

### 11.3 CLAIM

If a product has developed a fault during the warranty period as result of a defect in design or manufacturing, you may forward a warranty claim.

- Claims are to be forwarded as soon as a defect is discovered and not later than 2 weeks after the defect is discovered.
- Claims are to be addressed to the sales agent of the wheelchair. Please note that sales documentation has to be filled in and signed correctly with serial number and eventually NeC number in order to document time and place of the purchase of the wheelchair.
- The sales agent and Alu Rehab are to decide whether a defect is covered by the warranty. The claimer will be informed about the decision as soon as possible.
- If the claim is accepted, the sales agent and Alu Rehab representative are to decide if the product will be repaired, replaced or the customer is entitled to a reduced price.
- If a warranty claim is judged to be invalid – after careful inspection of the defect (defect due to wrong use and / or lack of required maintenance) you are free to decide if you want to have the defect product repaired (if possible) at your expense, or if you want to purchase a new product.



**Normal wear, incorrect use or incorrect handling is not a reason for claims.**



**The user is responsible for the use, maintenance and handling of the wheelchair as described in the user manual if claims are to be accepted.**

### 11.4 NETTI CUSTOMIZED / INDIVIDUAL ADAPTATIONS

Netti customized / individual adaptations are defined as all adjustments that are not included in this manual. Individual adaptations made by Alu Rehab are labelled with a unique NeC number for identification.

Wheelchairs that are especially adjusted /adapted by the customer cannot keep the CE mark given by Alu Rehab A.S Norway.

If the adjustments are performed by other than Alu Rehab approved dealers, the warranty given by Alu Rehab A.S Norway will not be valid.

If there are any uncertainty about special fitting and adaptations, please contact Alu Rehab A.S.



**If you have different needs than what our standard wheelchair program can cover, please take contact with customer service for eventually special adjustments or individual solutions.**

## 11.5 COMBINATIONS WITH OTHER PRODUCTS

Combinations of Netti and other products not manufactured by Alu Rehab A.S; generally, in these cases, the CE mark of all the products involved will not be valid.

However, Alu Rehab A.S has made agreements with some manufacturers about some combinations. By these combinations the CE mark and guarantees are valid.

 **For further information, please contact your dealer or Alu Rehab A.S Norway directly.**

### PRODUCT RESPONSIBILITY

Netti Vision with different configurations of Netti equipment has been tested / risk evaluated by Alu Rehab.

Any alterations or substitutions must not be made to the wheelchair securement points or to structural and frame parts without consulting the wheelchair manufacturer Alu Rehab.

Substitutions or alterations of components from third part suppliers to Netti Vision requires the risk evaluation and acceptance of the product responsibility and safety for use of the wheelchair from the manufacturer that is performing the substitution or alteration.

## 11.6 SERVICE AND REPAIR

 **Information about service and repair services in your area, please contact your local dealer.**

 **A unique identification number / serial number is to be found on the wheel frame on left side of the chair.**

 **A spare part catalogue for the wheelchair can be obtained through your local dealer or downloaded at [www.My-Netti.com](http://www.My-Netti.com)**

 **A refurbishment manual for the wheelchair can be obtained through your local dealer or downloaded at [www.My-Netti.com](http://www.My-Netti.com)**

 **Information about product safety and eventually recalls are found on our home page [www. My-Netti.com](http://www.My-Netti.com)**

 **A recycling manual for the wheelchair can be obtained through your local dealer or downloaded at [www.My-Netti.com](http://www.My-Netti.com)**

## 12. MEASURES & WEIGHT

Seat width*	Seat depth**	Backrest height ***	Total width	Transport width	Weight
400 mm	350 – 425 mm	455 mm	551 mm	283 mm	22,0 kg

\* Measured between skirt guards.

\*\* Measured from front of seat plate to backrest hinge.

\*\*\* Measured from the seat plate to top of backrest.

 The weight is including main wheels, front castors, leg supports and arm supports. No cushion.

 Max user weight is 100 kg.

 Eventual luggage loaded on to the wheelchair must not exceed 10 kg. The luggage must not be placed in a manner that reduce the stability of the chair.

### 12.1 OVERALL DIMENSIONS IN MINIMAL USER POSITION

#### SIDE VIEW

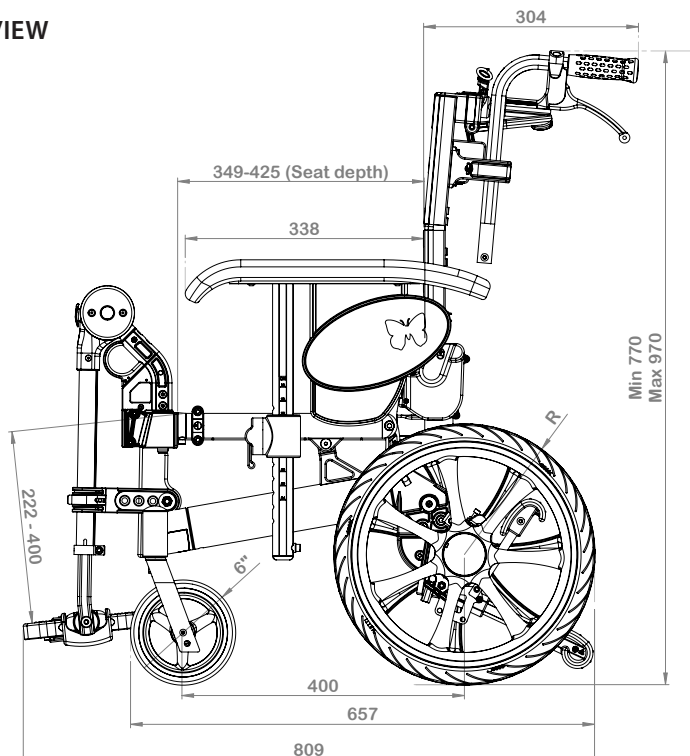

**FRONT VIEW**

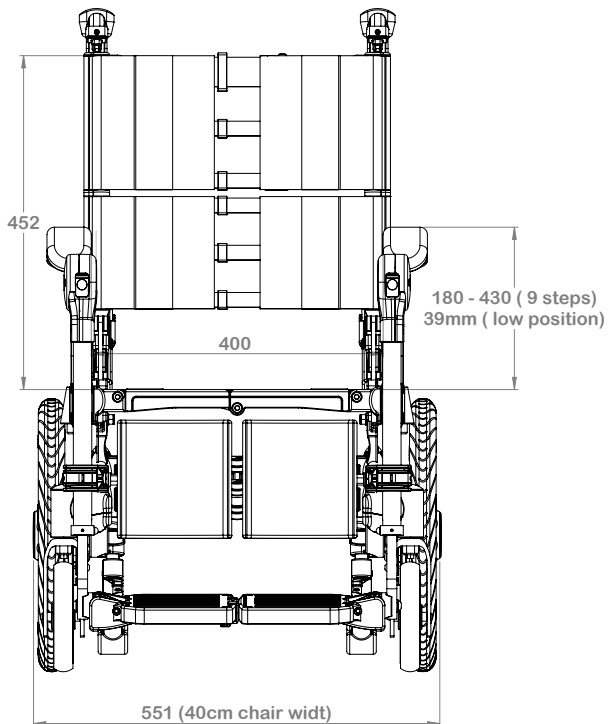

## 12.2 TILT, RECLINE AND FOOT SUPPORT DIMENSIONS

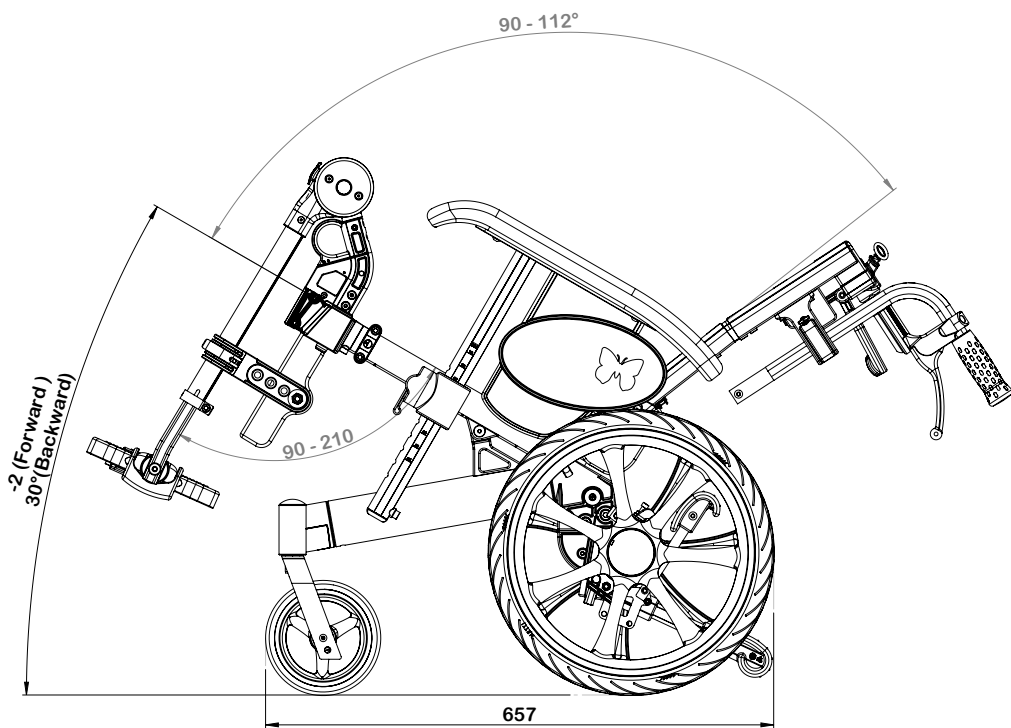

## 12.3 TURNING RADIUS

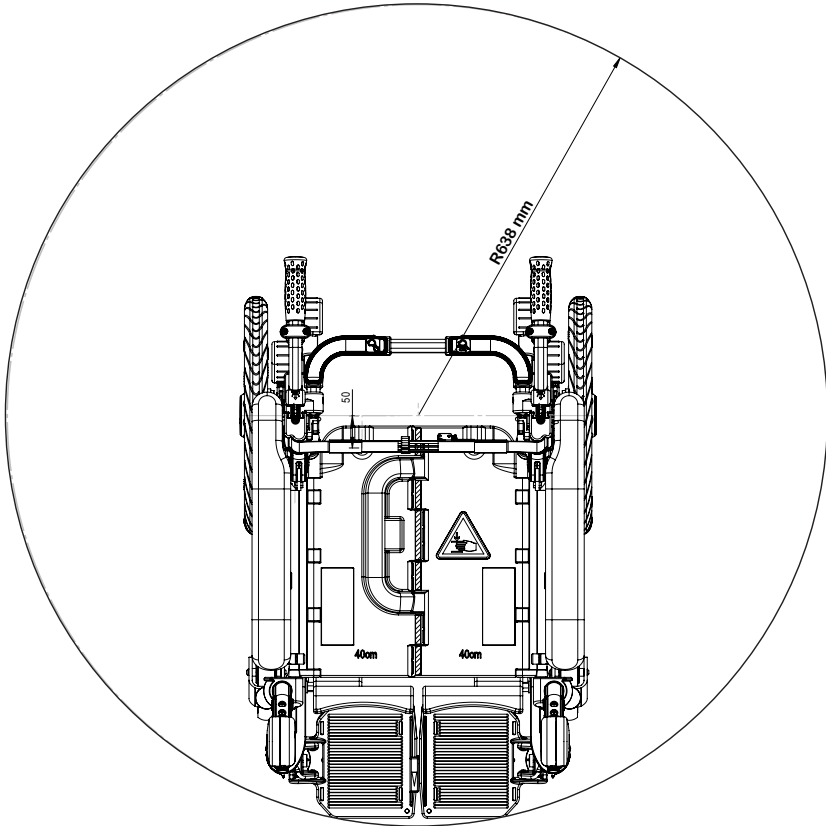

**SIDE VIEW DIMENSIONS -  
FOLDED**

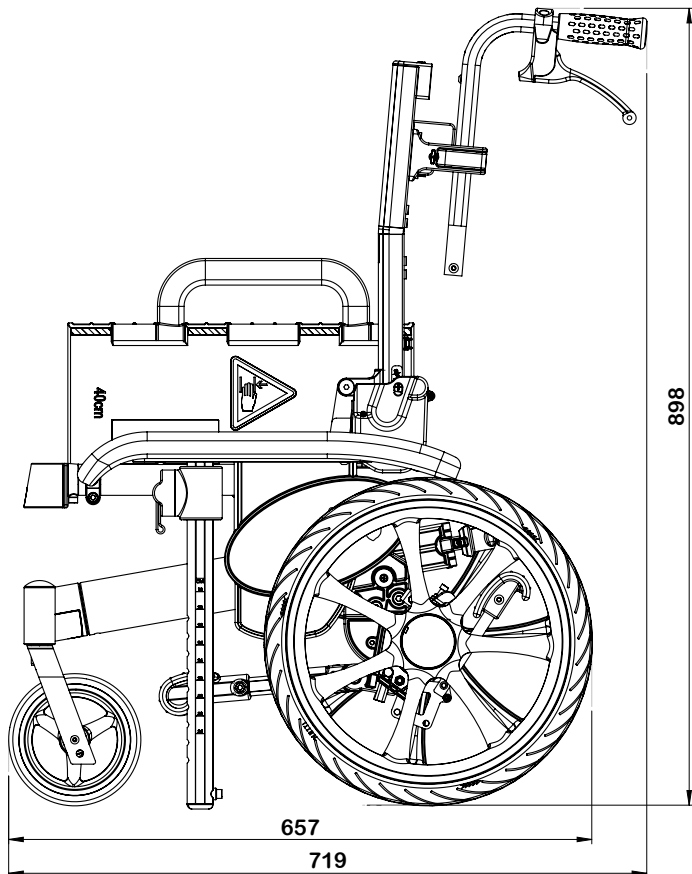



## FRONT VIEW DIMENSIONS - FOLDED

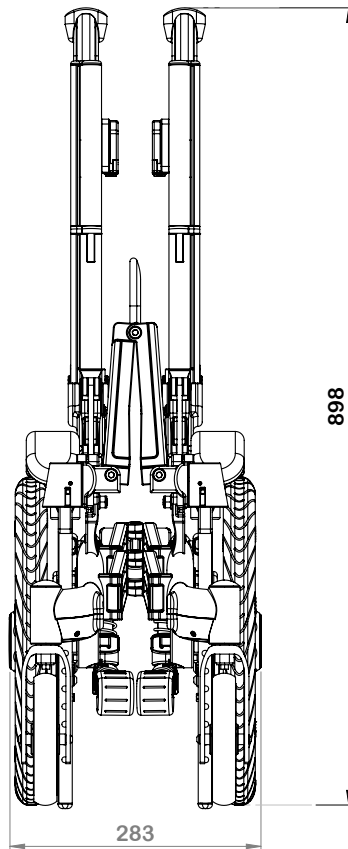







**Manufacturer:**

Alu Rehab AS  
Bedriftsvegen 23  
N-4353 Klepp Stasjon  
Norway



post@My-Netti.com  
T: +47 51 78 62 20  
my-netti.no

---

**Distributor**



Alu Rehab ApS  
Kløftehøj 8  
DK-8680 Ry  
Denmark



info@my-netti.com  
T: +45 87 88 73 00  
F: +45 87 88 73 19  
my-netti.dk

**Distributor**

Meyra GmbH  
Meyra-Ring 2  
D-32689 Kalletal  
Germany

info@my-netti.com  
T: +49 5733 922 311  
F: +49 5733 922 9311  
my-netti.de

**Distributor**

MDH Sp. zo.o.  
ul. W. Tymienieckiego 22/24  
90-349 Łódź  
Poland

biuro@mdh.pl  
T: +48 42 674 83 84  
my-netti.com

---